



Kraus & Naimer
BLUE LINE switchgear

DISCONNECTORS FOR PHOTOVOLTAIC



www.krausnaimer.com

next ▶



WORDWIDE SYMBOL
FOR QUALITY SWITCHGEAR

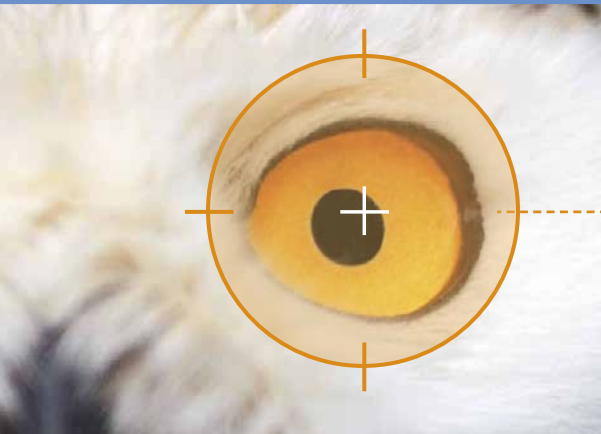

We are focused
on the solution

Disconnectors for

Photovoltaic

Please select the accurate switch disconnector according to the power performance of your Photovoltaic application.

< For direct link click on the page number >

Contact development: 1 x 2 pole			
Rated Operational		Screw/Snap on Base Mounting	In Enclosure
Voltage	Current	Page	Page
450 V	16 A	4	9
	25 A	4	9
	32 A	4	9
500 V	12 A	4	9
	20 A	4	9
	32 A	5	10
650 V	16 A	5	10
	25 A	5	10
	32 A	5	10
	63 A	7	12
800 V	12 A	5	10
	16 A	6	11
	25 A	6	11
	32 A	6	11
	64 A	8	12
Contact development: 1 x 2 pole, 2 x 2 pole and 3 x 2 pole			
Rated Operational		Panel Mounting	
Voltage	Current	Page	
500 V	20 A	13	
750 V	20 A	14	
1000 V	20 A	15	

Note: UL-approved switches on request

DC Disconnectors for Solar Photovoltaic (PV) Power Supply System
acc. to IEC 60364-7-712:2002

Disconnectors for
Photovoltaic

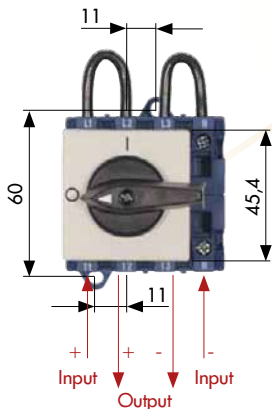
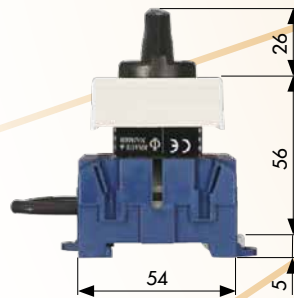
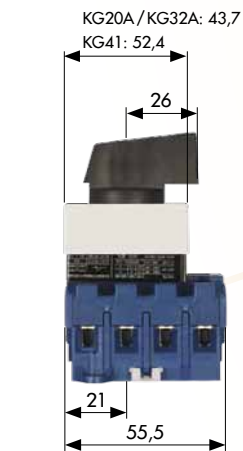

Connecting diagram	Tightening torque for terminal screws	Strip length
	KG20A/ KG32A 1,25 Nm	KG20A/ KG32A 9
	KG41 1,80 Nm	KG41 10

Contact development: 2 pole, 4 contacts per circuit (2 x 2 in series)

Back to the table of contents >

General Data

Switch Disconnecter according to EN 60947-3 respectively VDE 0660 Part 107

Utilization Category: DC-22 A for Photovoltaic Application

Ambient Temperature (open): 50 °C during 24 hours with peaks up to 55 °C

Terminal Lugs finger-proof according to VDE 0660-514 and BGV A3, IP 20

Maximum permissible wire gage (use copper wire only)

single core wire or stranded wire

KG20A / KG32A: 6 mm² KG41: 16 mm²

flexible wire

KG20A / KG32A: 4 mm² KG41: 10 mm²

Mounting

Screw/Snap on base mounting for track EN 60715

Escutcheon plate for 45 mm standard knock-out, F-handle black

Rated Value / Order Number

	16 A	25 A	32 A
Operational Current	16 A	25 A	32 A
Operational Voltage	450 V DC	450 V DC	450 V DC
Max. Off load voltage of the PV inverter	520 V DC	520 V DC	520 V DC
Insulation Voltage	690 V	690 V	690 V
Operational Current	12 A	20 A	
Operational Voltage	500 V DC	500 V DC	
Max. Off load voltage of the PV inverter	575 V DC	575 V DC	
Insulation Voltage	690 V	690 V	
Order Number	KG20A T304/D-P001 VE2	KG32A T304/D-P001 VE2	KG41 T304/D-P001 VE2



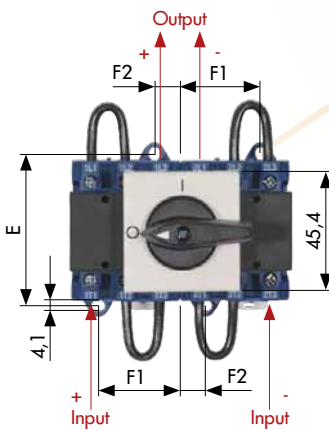
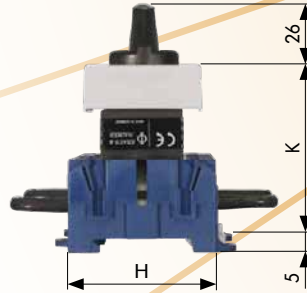

Data valid only, if the pre-assembled jumpers have not been modified.

DC Disconnectors for Solar Photovoltaic (PV) Power Supply System
acc. to IEC 60364-7-712:2002

Disconnectors for
Photovoltaic

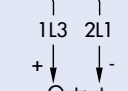

	KG20A/ KG32A	KG41B
A	43,7	105,4
E	60	70
F1	32	37,5
F2	10	12,5
G	84	100
H	54	64
K	64	62,5

Connecting diagram	Tightening torque for terminal screws	Strip length
	KG20A/ KG32A 1,25 Nm	KG20A/ KG32A 9 
	KG41B 1,80 Nm	KG41B 10 

Contact development: 2 pole, 6 contacts per circuit (2 x 3 in series)

Back to the table of contents >

General Data

Switch Disconnector according to EN 60947-3 respectively VDE 0660 Part 107
Utilization Category: DC-22 A for Photovoltaic Application
Ambient Temperature (open): 50 °C during 24 hours with peaks up to 55 °C
Terminal Lugs finger-proof according to VDE 0660-514 and BGV A3, IP 20
Maximum permissible wire gage (use copper wire only)
single core wire or stranded wire
flexible wire

KG20A / KG32A: 6 mm ²	KG41: 16 mm ²
KG20A / KG32A: 4 mm ²	KG41: 10 mm ²

Mounting

Screw/Snap on base mounting for track EN 60715
Escutcheon plate for 45 mm standard knock-out, F-handle black

Rated Value / Order Number

Operational Current	16 A	32 A	32 A
Operational Voltage	650 V DC	500 V DC	650 V DC
Max. Off load voltage of the PV inverter	750 V DC	575 V DC	750 V DC
Insulation Voltage	1000 V	1000 V	1000 V
Operational Current	12 A	25 A	
Operational Voltage	800 V DC	650 V DC	
Max. Off load voltage of the PV inverter	920 V DC	750 V DC	
Insulation Voltage	1000 V	1000 V	
Order Number	KG20A T306/D-P001 VE2	KG32A T306/D-P001 VE2	KG41B T306/D-P001 VE2

Data valid only, if the pre-assembled jumpers have not been modified.

DC Disconnectors for Solar Photovoltaic (PV) Power Supply System
acc. to IEC 60364-7-712:2002

Disconnectors for
Photovoltaic

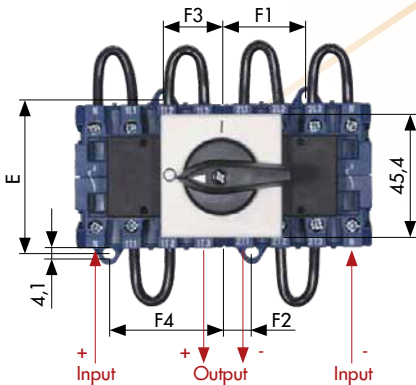
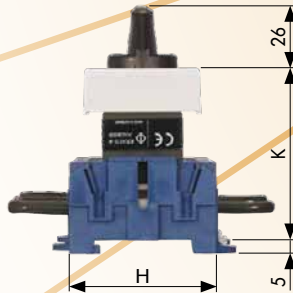
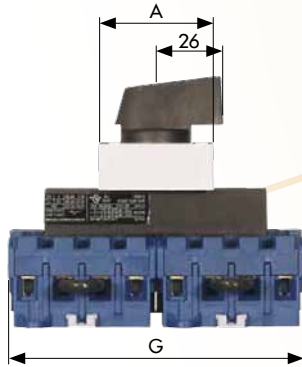

	KG20A/ KG32A	KG41B
A	43,7	105,4
E	60	70
F1	32	37,5
F2	10	12,5
F3	23,5	28,5
F4	45,5	53,5
G	111	132
H	54	64
K	64	62,5

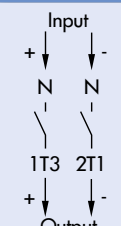
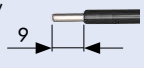
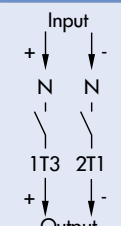
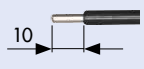
Connecting diagram	Tightening torque for terminal screws	Strip length
	1,25 Nm	KG20A/ KG32A 9 
	1,80 Nm	KG41B 10 

Contact development: 2 pole, 8 contacts per circuit (2 x 4 in series)

Back to the table of contents >

General Data

Switch Disconnecter according to EN 60947-3 respectively VDE 0660 Part 107

Utilization Category: DC-22 A for Photovoltaic Application

Ambient Temperature (open): 50 °C during 24 hours with peaks up to 55 °C

Terminal Lugs finger-proof according to VDE 0660-514 and BGV A3, IP 20

Maximum permissible wire gage (use copper wire only)

single core wire or stranded wire

KG20A / KG32A: 6 mm² KG41: 16 mm²

flexible wire

KG20A / KG32A: 4 mm² KG41: 10 mm²

Mounting

Screw/Snap on base mounting for track EN 60715

Escutcheon plate for 45 mm standard knock-out, F-handle black

Rated Value / Order Number

	16 A	25 A	32 A
Operational Current	16 A	25 A	32 A
Operational Voltage	800 V DC	800 V DC	800 V DC
Max. Off load voltage of the PV inverter	920 V DC	920 V DC	920 V DC
Insulation Voltage	1000 V	1000 V	1000 V

Order Number	KG20A T308/D-P001 VE2	KG32A T308/D-P001 VE2	KG41B T308/D-P001 VE2
--------------	-----------------------	-----------------------	-----------------------

DC Disconnectors for Solar Photovoltaic (PV) Power Supply System
acc. to IEC 60364-7-712:2002

Disconnectors for
Photovoltaic

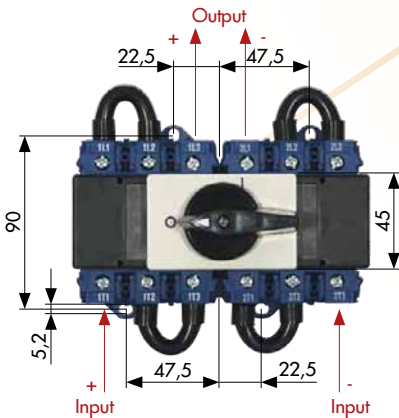
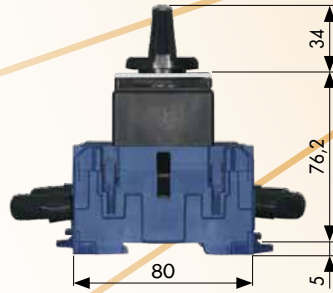
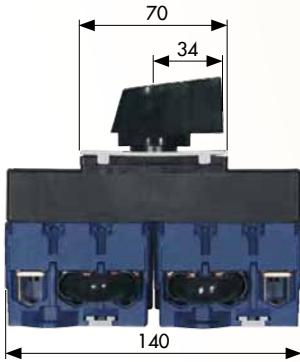

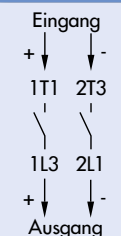
Connecting diagram	Tightening torque for terminal screws	Strip length
	KG80 3,00 Nm	KG80 14 

Contact development: 2 pole, 6 contacts per circuit (2 x 3 in series)

Back to the table of contents >

General Data

Switch Disconnecter according to EN 60947-3 respectively VDE 0660 Part 107
Utilization Category: DC-22 B for Photovoltaic Application
Ambient Temperature (open): 50 °C during 24 hours with peaks up to 55 °C
Terminal Lugs finger-proof according to VDE 0660-514 and BGV A3, IP 20
Maximum permissible wire gage (use copper wire only)
single core wire or stranded wire 50 mm²
flexible wire 35 mm²

Mounting

Screw/Snap on base mounting for track EN 60715
Escutcheon plate for 45 mm standard knock-out, F-handle black

Rated Value / Order Number

Operational Current	63 A
Operational Voltage	650 V DC
Max. Off load voltage of the PV inverter	750 V DC
Insulation Voltage	1000 V

Order Number **KG80 T306/D-P001 VE2**

Data valid only, if the pre-assembled jumpers have not been modified.

DC Disconnectors for Solar Photovoltaic (PV) Power Supply System
acc. to IEC 60364-7-712:2002

Disconnectors for
Photovoltaic

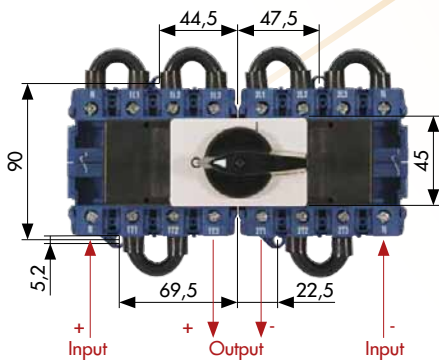
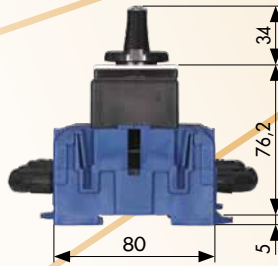
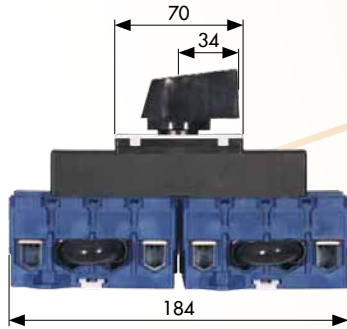

Connecting diagram	Tightening torque for terminal screws	Strip length
	KG80 3,00 Nm	KG80 14 

Contact development: 2 pole, 8 contacts per circuit (2 x 4 in series)

Back to the table of contents >

General Data

Switch Disconnector according to EN 60947-3 respectively VDE 0660 Part 107
Utilization Category: DC-22 B for Photovoltaic Application
Ambient Temperature (open): 50 °C during 24 hours with peaks up to 55 °C
Terminal Lugs finger-proof according to VDE 0660-514 and BGV A3, IP 20
Maximum permissible wire gage (use copper wire only)
single core wire or stranded wire 50 mm²
flexible wire 35 mm²

Mounting

Screw/Snap on base mounting for track EN 60715
Escutcheon plate for 45 mm standard knock-out, F-handle black

Rated Value / Order Number

Operational Current	64 A
Operational Voltage	800 V DC
Max. Off load voltage of the PV inverter	920 V DC
Insulation Voltage	1000 V



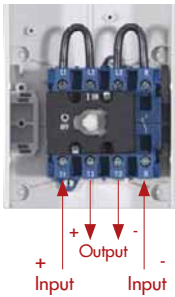
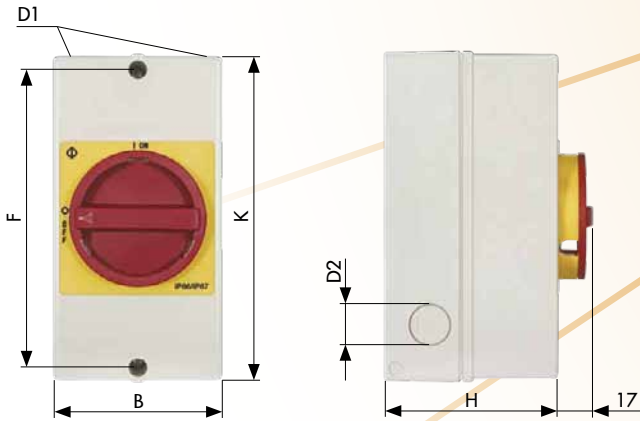

Order Number **KG80 T308/D-P001 VE2**

DC Disconnectors for Solar Photovoltaic (PV) Power Supply System
acc. to IEC 60364-7-712:2002

Disconnectors for
Photovoltaic

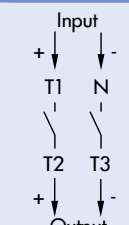

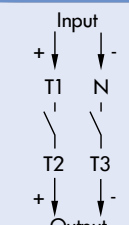
	KG20/ KG32	KG41
B	85	100
D1	2 x Ø 20	2 x Ø 25
D2	Ø 20	Ø 25
F	150	178
H	82	93
K	160	190

Connecting diagram	Tightening torque for terminal screws	Strip length
	KG20/ KG32 1,25 Nm	KG20/ KG32 9 
	KG41 1,80 Nm	KG41 10 

Contact development: 2 pole, 4 contacts per circuit (2 x 2 in series)

Back to the table of contents >

General Data

Switch Disconnector according to EN 60947-3 respectively VDE 0660 Part 107

Utilization Category: DC-22 A for Photovoltaic Application

Ambient Temperature (enclosed): 50 °C during 24 hours with peaks up to 55 °C

Terminal Lugs finger-proof according to VDE 0660-514 and BGV A3, IP 20

Maximum permissible wire gage (use copper wire only)

single core wire or stranded wire	KG20/KG32: 6 mm ²	KG41: 16 mm ²
flexible wire	KG20/KG32: 4 mm ²	KG41: 10 mm ²

Mounting

Plastic Enclosure, Protection IP66/67, totally insulated, knock-out entries,

Red handle and contrasting yellow escutcheon plate, OFF-position lockable with padlocks, cover coupling with interlock

Rated Value / Order Number

	16 A	25 A	32 A
Operational Current	16 A	25 A	32 A
Operational Voltage	450 V DC	450 V DC	450 V DC
Max. Off load voltage of the PV inverter	520 V DC	520 V DC	520 V DC
Insulation Voltage	690 V	690 V	690 V
Operational Current	12 A	20 A	
Operational Voltage	500 V DC	500 V DC	
Max. Off load voltage of the PV inverter	575 V DC	575 V DC	
Insulation Voltage	690 V	690 V	
Order Number	KG20 T204/D-P003 KL51V	KG32 T204/D-P003 KL51V	KG41 T204/D-P003 KL11V



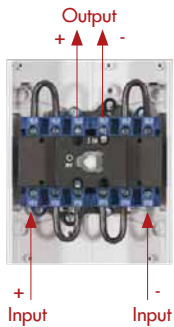
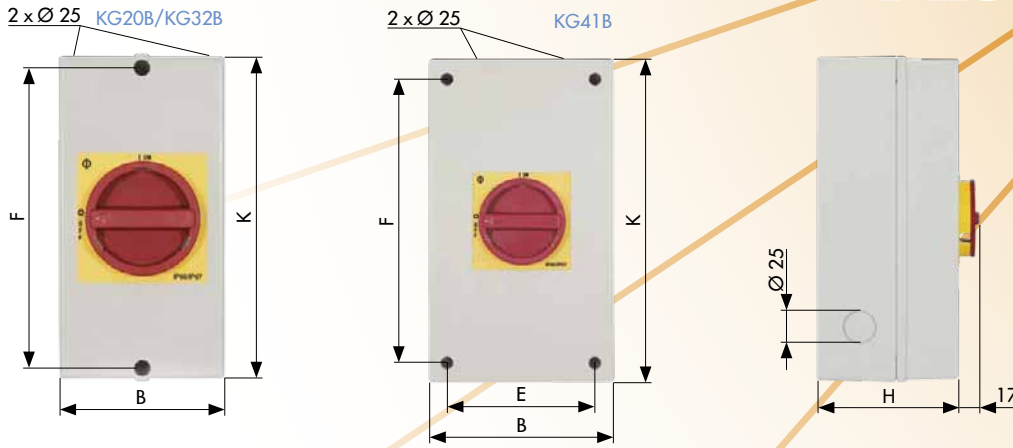

Data valid only, if the pre-assembled jumpers have not been modified.

DC Disconnectors for Solar Photovoltaic (PV) Power Supply System
acc. to IEC 60364-7-712:2002

Disconnectors for
Photovoltaic



	KG20B/ KG32B	KG41B
B	100	145
E	—	124
F	178	229
H	93	107
K	190	250

Connecting diagram	Tightening torque for terminal screws	Strip length
	KG20B/ KG32B 1,25 Nm	KG20B/ KG32B 9 
	KG41B 1,80 Nm	KG41B 10 

Contact development: 2 pole, 6 contacts per circuit (2 x 3 in series)

Back to the table of contents >

General Data

Switch Disconnector according to EN 60947-3 respectively VDE 0660 Part 107
Utilization Category: DC-22 A for Photovoltaic Application
Ambient Temperature (enclosed): 50 °C during 24 hours with peaks up to 55 °C (KG32B from 26 A: 35 °C during 24 hours with peaks up to 40 °C)
Terminal Lugs finger-proof according to VDE 0660-514 and BGV A3, IP 20
Maximum permissible wire gage (use copper wire only)
single core wire or stranded wire KG20/KG32: 6 mm² KG41: 16 mm²
flexible wire KG20/KG32: 4 mm² KG41: 10 mm²

Mounting

Plastic Enclosure, Protection IP66/67, totally insulated, knock-out entries,
Red handle and contrasting yellow escutcheon plate, OFF-position lockable with padlocks, cover coupling with interlock

Rated Value / Order Number

	16 A	32 A	32 A
Operational Current	16 A	32 A	32 A
Operational Voltage	650 V DC	500 V DC	650 V DC
Max. Off load voltage of the PV inverter	750 V DC	575 V DC	750 V DC
Insulation Voltage	1000 V	1000 V	1000 V
Operational Current	12 A	25 A	
Operational Voltage	800 V DC	650 V DC	
Max. Off load voltage of the PV inverter	920 V DC	750 V DC	
Insulation Voltage	1000 V	1000 V	
Order Number	KG20B T206/D-P003 KL11V	KG32B T206/D-P003 KL11V	KG41B T206/D-P003 KL11V

Data valid only, if the pre-assembled jumpers have not been modified.

DC Disconnectors for Solar Photovoltaic (PV) Power Supply System
acc. to IEC 60364-7-712:2002

Disconnectors for
Photovoltaic

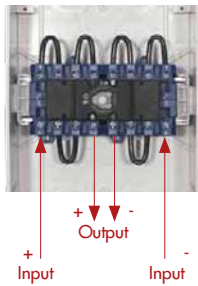
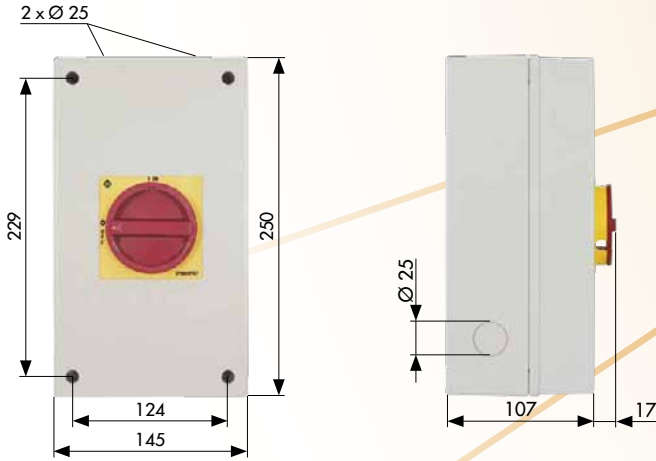

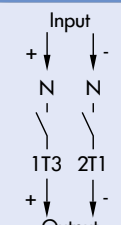
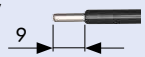
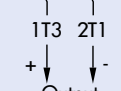
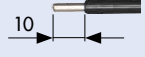
Connecting diagram	Tightening torque for terminal screws	Strip length
	KG20B/ KG32B 1,25 Nm	KG20B/ KG32B 9 
	KG41B 1,80 Nm	KG41B 10 

Contact development: 2 pole, 8 contacts per circuit (2 x 4 in series)

Back to the table of contents >

General Data

Switch Disconnector according to EN 60947-3 respectively VDE 0660 Part 107

Utilization Category: DC-22 A for Photovoltaic Application

Ambient Temperature (enclosed): 50 °C during 24 hours with peaks up to 55 °C

Terminal Lugs finger-proof according to VDE 0660-514 and BGV A3, IP 20

Maximum permissible wire gage (use copper wire only)

single core wire or stranded wire	KG20 / KG32: 6 mm ²	KG41: 16 mm ²
flexible wire	KG20 / KG32: 4 mm ²	KG41: 10 mm ²

Mounting

Plastic Enclosure, Protection IP66/67, totally insulated, knock-out entries,

Red handle and contrasting yellow escutcheon plate, OFF-position lockable with padlocks, cover coupling with interlock

Rated Value / Order Number

	16 A	25 A	32 A
Operational Current	16 A	25 A	32 A
Operational Voltage	800 V DC	800 V DC	800 V DC
Max. Off load voltage of the PV inverter	920 V DC	920 V DC	920 V DC
Insulation Voltage	1000 V	1000 V	1000 V

Order Number **KG20B T208/D-P003 KL11V** **KG32B T208/D-P003 KL11V** **KG41B T208/D-P003 KL11V**

DC Disconnectors for Solar Photovoltaic (PV) Power Supply System
acc. to IEC 60364-7-712:2002

Disconnectors for
Photovoltaic

650 V DC

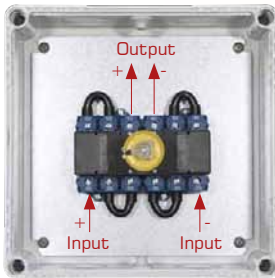

Contact development: 2 pole
6 contacts per circuit (2 x 3 in series)

800 V DC

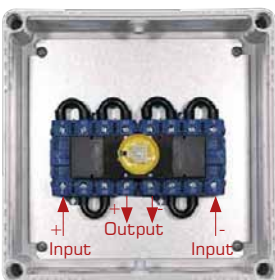

Contact development: 2 pole
8 contacts per circuit (2 x 4 in series)

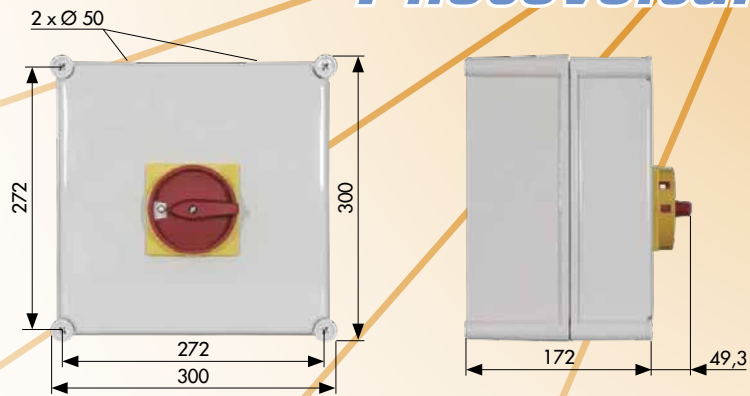

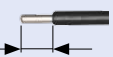
Connecting diagram 6 contacts	Connecting diagram 8 contacts	Tightening torque for terminal screws	Strip length
<pre> Input + - 1T1 2T3 / \ 1L3 2L1 + - Output </pre>	<pre> Input + - N N / \ 1T3 2T1 + - Output </pre>	KG80C 3,00 Nm	KG80C 14 

Back to the table of contents >

General Data

Switch Disconnector according to EN 60947-3 respectively VDE 0660 Part 107
Utilization Category: DC-22 B for Photovoltaic Application
Ambient Temperature (enclosed): 50 °C during 24 hours with peaks up to 55 °C
Terminal Lugs finger-proof according to VDE 0660-514 and BGV A3
Maximum permissible wire gage (use copper wire only)
single core wire or stranded wire 50 mm²
flexible wire 35 mm²

Mounting

Plastic Enclosure, Protection IP66/67, totally insulated, knock-out entries,
Red handle and contrasting yellow escutcheon plate, OFF-position lockable with padlocks, cover coupling with interlock

Rated Value / Order Number

	63 A 650 V DC	64 A 800 V DC
Operational Current	63 A	64 A
Operational Voltage	650 V DC	800 V DC
Max. Off load voltage of the PV inverter	750 V DC	920 V DC
Insulation Voltage	1000 V	1000 V

Order Number **KG80C T206/D-P003 STM** **KG80C T208/D-P003 STM**

Data valid only, if the pre-assembled jumpers have not been modified.

DC Disconnectors for Solar Photovoltaic (PV) Power Supply System
acc. to IEC 60364-7-712:2002

Disconnectors for
Photovoltaic

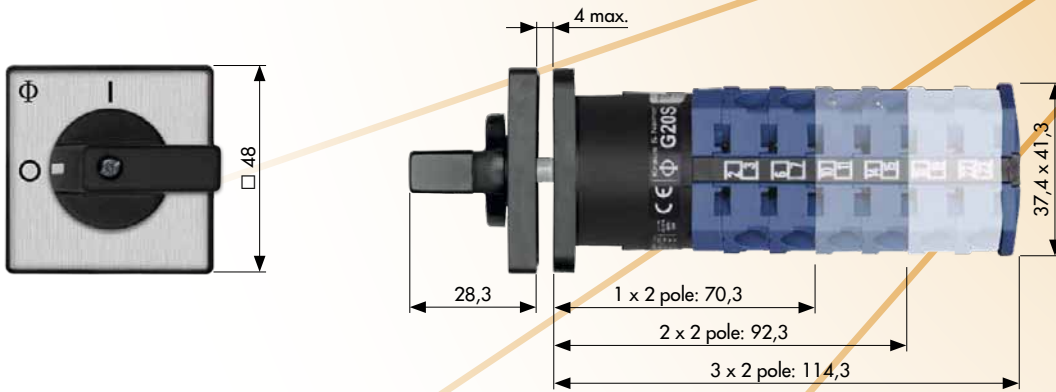

Drilling plan	Tightening torque for terminal screws	
	G20S	0,8 Nm
	Strip length	
	G20S	8

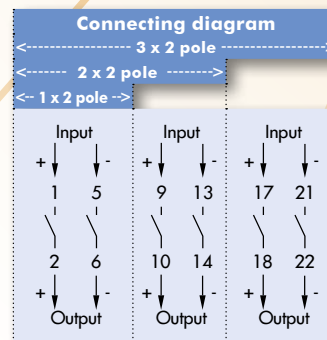

Contact development: 1 x 2 pole, 2 x 2 pole and 3 x 2 pole

General Data

Switch Disconnecter according to EN 60947-3 respectively VDE 0660 Part 107
Utilization Category: DC-22 A for Photovoltaic Application
Ambient Temperature (open): 55 °C during 24 hours, 65 °C during 8 hours
Terminal Lugs finger-proof according to VDE 0660-514 and BGV A3, IP 20
Maximum permissible wire gage (use copper wire only)
single core wire or stranded wire 2 x 2,5 mm²
flexible wire 2 x 2,5 mm²

Mounting

Four hole panel mounting, panel thickness max. 4 mm,
Escutcheon Plate Backing brushed alu, standard handle

Rated Value / Order Number

	1 x 2 pole	2 x 2 pole	3 x 2 pole
Operational Current	20 A	20 A	20 A
Operational Voltage	500 V DC	500 V DC	500 V DC
Max. Off load voltage of the PV inverter	630 V DC	630 V DC	630 V DC
Insulation Voltage	630 V	630 V	630 V
Order Number	G20S TD3102 E	G20S TD3104 E	G20S TD3106 E

Data valid only, if the pre-assembled jumpers have not been modified.

DC Disconnectors for Solar Photovoltaic (PV) Power Supply System
acc. to IEC 60364-7-712:2002

Disconnectors for
Photovoltaic

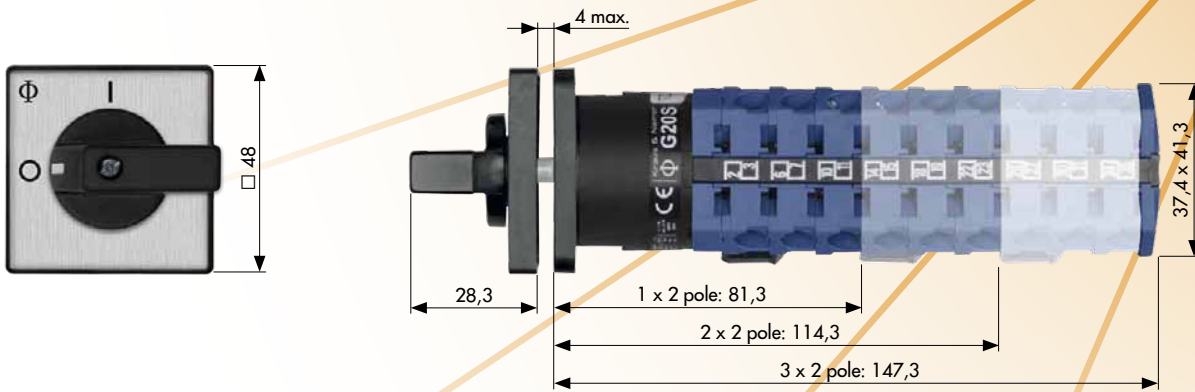

Drilling plan	Tightening torque for terminal screws	
	G20S	0,8 Nm
	Strip length	
	G20S	8

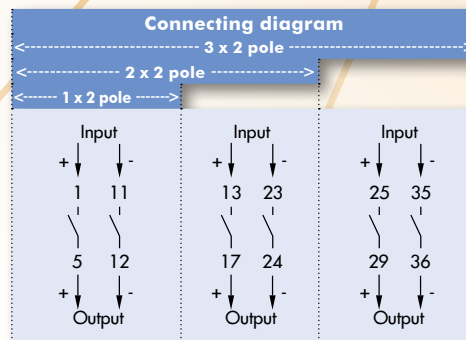

Contact development: 1 x 2 pole, 2 x 2 pole und 3 x 2 pole

General Data	
Switch Disconnecter according to EN 60947-3 respectively VDE 0660 Part 107	
Utilization Category: DC-22 A for Photovoltaic Application	
Ambient Temperature (open): 55 °C during 24 hours, 65 °C during 8 hours	
Terminal Lugs finger-proof according to VDE 0660-514 and BGV A3, IP 20	
Maximum permissible wire gage (use copper wire only)	
single core wire or stranded wire	2 x 2,5 mm ²
flexible wire	2 x 2,5 mm ²
Configuration	
Four hole panel mounting, panel thickness max. 4 mm,	
Escutcheon Plate Backing brushed alu, standard handle	

Rated Value / Order Number			
	1 x 2 pole	2 x 2 pole	3 x 2 pole
Operational Current	20 A	20 A	20 A
Operational Voltage	750 V DC	750 V DC	750 V DC
Max. Off load voltage of the PV inverter	1000 V DC	1000 V DC	1000 V DC
Insulation Voltage	1000 V	1000 V	1000 V
Order Number	G20S TD3351 E	G20S TD3352 E	G20S TD3353 E

Data valid only, if the pre-assembled jumpers have not been modified.

DC Disconnectors for Solar Photovoltaic (PV) Power Supply System
acc. to IEC 60364-7-712:2002

Disconnectors for
Photovoltaic

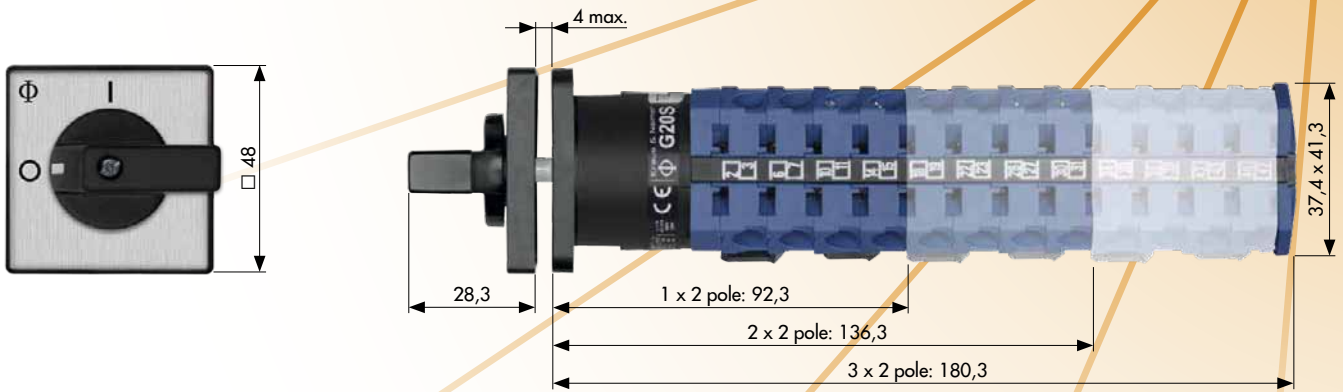

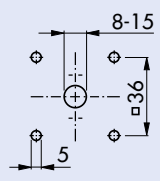
Drilling plan	Tightening torque for terminal screws	
	G20S	0,8 Nm
	Strip length	
	G20S	8

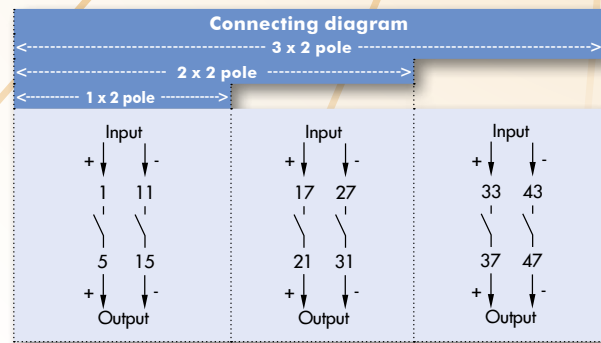

Contact development: 1 x 2 pole, 2 x 2 pole und 3 x 2 pole

General Data

Switch Disconnector according to EN 60947-3 respectively VDE 0660 Part 107
Utilization Category: DC-22 A for Photovoltaic Application
Ambient Temperature (open): 55 °C during 24 hours, 65 °C during 8 hours
Terminal Lugs finger-proof according to VDE 0660-514 and BGV A3, IP 20
Maximum permissible wire gage (use copper wire only)
single core wire or stranded wire 2 x 2,5 mm²
flexible wire 2 x 2,5 mm²

Configuration

Four hole panel mounting, panel thickness max. 4 mm,
Escutcheon Plate Backing brushed alu, standard handle

Rated Value / Order Number

	1 x 2 pole	2 x 2 pole	3 x 2 pole
Operational Current	20 A	20 A	20 A
Operational Voltage	1000 V DC	1000 V DC	1000 V DC
Max. Off load voltage of the PV inverter	1000 V DC	1000 V DC	1000 V DC
Insulation Voltage	1000 V	1000 V	1000 V
Order Number	G20S TD3202 E	G20S TD3204 E	G20S TD3206 E

Data valid only, if the pre-assembled jumpers have not been modified.



Kraus & Naimer

BLUE LINE switchgear

www.krausnaimer.com

