



Kraus & Naimer

BLUE LINE switchgear

since 1907

Catalog 100

09/2018

Control and Load Switches for higher Capacities

CAD, CA and C type up to 315 A
L type up to 2400 A

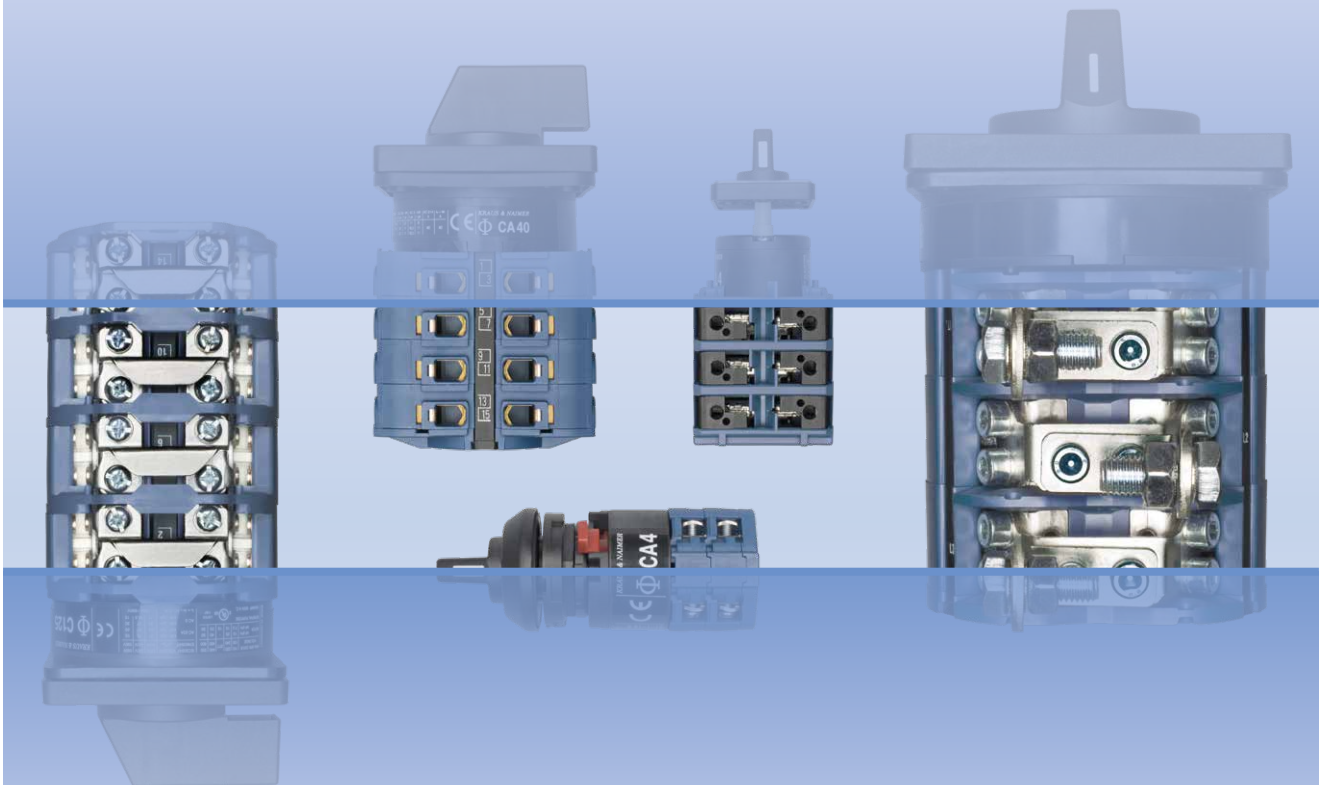

Kraus & Naimer

The development of the Blue Line rotary switch, contactor and motor starter product ranges is based on more than hundred years experience by Kraus & Naimer in the design and manufacture of electrical switchgear. Kraus & Naimer pioneered the introduction of the cam operated rotary switch and continues to be recognized as the world leader in that product field.

BLUE LINE

Blue Line products are protected by numerous patents throughout the industrial world. They are built to national and international standards and designed to withstand adverse temperatures and climates.

Blue Line products are accepted and universally recognized for their quality and workmanship. They are supported by a worldwide sales and service organization.

The Kraus & Naimer Registered Trademark



WORLDWIDE SYMBOL
FOR QUALITY SWITCHGEAR

Disconnectors and Main Switches acc. to IEC 60947-3 see Catalog 500

| Contents | Page |
|---------------------------------------|-------------|
| Construction Data | 4 |
| Dimensions and Nominal Ratings | 5 |
| How to order | 6, 7 |
| Switch Function and Configuration | |
| C, CA and CAD Switches 10 A-315 A | |
| ON/OFF Switches | 9 |
| Double-throw Switches | 10-12 |
| General Application Switches | 12 |
| Coding Switches | 13 |
| Multi-step Switches | 14-16 |
| Voltmeter Switches | 17-18 |
| Ammeter Switches | 19-21 |
| Volt-ammeter Switches | 21 |
| Control Switches | 21, 22 |
| Motor Switches | 23-25 |
| L Switches 350 A-2400 A | |
| ON/OFF Switches | 26, 27 |
| Double-throw Switches | 28, 29 |
| Multi-step Switches | 30-32 |
| Types of Mounting | |
| Panel Mounting | 33-37 |
| Base Mounting | 38 |
| Wall Mounting | 39 |
| Face Plates | 40, 41 |
| Handles | 42 |
| International Standards and Approvals | 43 |
| Technical Data | 44-48 |
| Dimensions | |
| Panel Mounting | 49-53 |
| Base Mounting | 53, 54 |
| Wall Mounting | 55 |
| Overall Switch Lengths | 55, 56 |
| Blue Line Switchgear: Summary | 58 |

Construction Data

The load switches of the C, CA and CAD-series offer a solution for most cam switch applications. Different contact designs, contact materials and terminals allow for their use as control switches, instrumentation switches and motor control switches, as well as in electronic circuitry and in aggressive environments according to IEC 60947-3 and VDE 0660 part 107.

The stage is the basis for all switches and can be supplied with a maximum of 2 contacts. The terminals are accessible from the side. CA and CAD switches are supplied with open terminals to facilitate wiring and are protected against accidental finger contact according to EN 50274, VDE 0660 part 514 and DGUV V3. Switches up to type CA25B are supplied with captive screws with clamping plates. The switch types CA40-CA63 are supplied with box terminals. Captive plus-minus terminal screws and integrated screwdriver guides facilitate wiring.

If a positive manual operation or a higher DC rating is required, many of these switches can be fitted with a snap action latching mechanism - suffix „S“ - to the switch type.

The cam-operated switches of the L-series are continuous current rated for off-load switching. They may be used to switch resistive or low inductive loads.

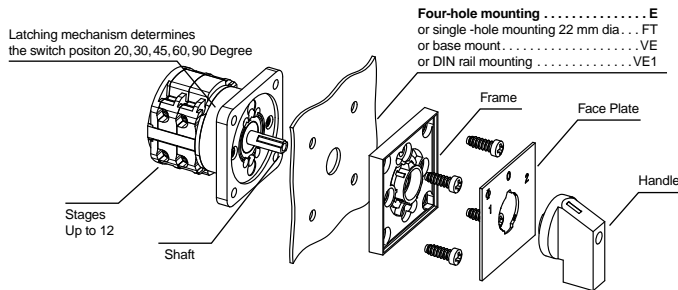

Special Contact Systems

CA4/CA4-1

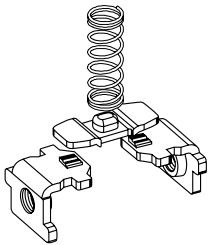

High contact reliability by multiple cross-point contacts, electronic compatible, CA4 with 1 μ and CA4-1 with 35 μ gold plating.

CAD4-1/CAD11/CAD12

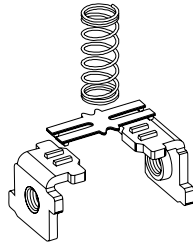

High contact reliability by H-bridge design with "cross-wire" contacts. The contact system with gold-plated contacts (CAD12 with silver contact) allows for low voltages, electronic compatible.

| Type | Size | Possible Switching Angles | Max. No. of Stages |
|---------------------------------------|------|---------------------------|--------------------|
| CA4, CA4-1, CAD4-1 | S00 | 30°, 45°, 60°, 90° | 9 |
| CA10-CA25 | S0 | 30°, 45°, 60°, 90° | 12 |
| CA10S-CA25S | S0 | 60°, 90° | on request |
| CAD11, CAD12 | S0 | 30°, 45°, 60°, 90° | 12 |
| CA10B-CA25B | S1 | 30°, 45°, 60°, 90° | 12 |
| C26, C32, C42 | S1 | 20°, 30°, 45°, 60°, 90° | 12 |
| C26S, C32S, C42S | S1 | 60° | on request |
| CA40, CA50, CA63 | S1 | 30°, 45°, 60°, 90° | 12 |
| C43, C80, C125, C200-4 | S2 | 20°, 30°, 45°, 60°, 90° | 12 |
| C315 | S3 | 20°, 30°, 45°, 60°, 90° | 12 |
| L350, L351, L630, L631 | S2 | 30°, 45°, 60°, 90° | 12 |
| L1000 | | | |
| L400, L600, L800, L1200, L1600, L2000 | S3 | 30°, 45°, 60°, 90° | 12 |

CA and CAD Switches (CA4-CA25B)



CA Switches (CA40-CA63)



C Switches



L Switches



Above illustrates the standard terminal positions.

Nominal Ratings

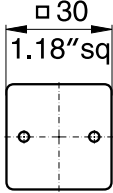
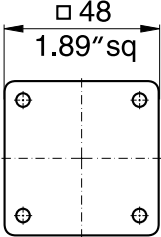
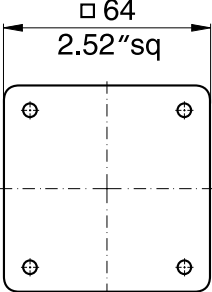
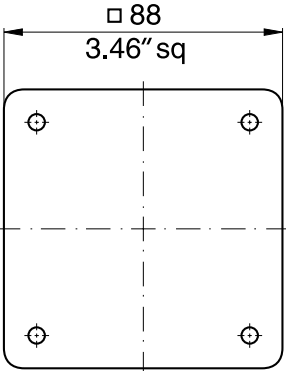
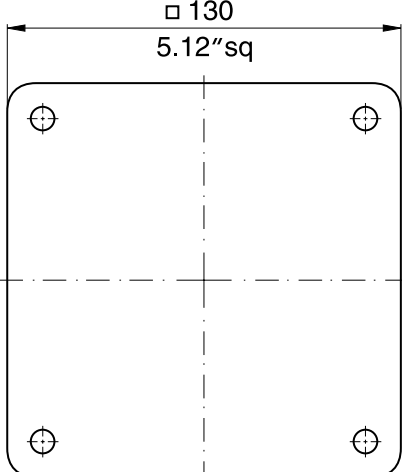
| Switch Size | Type | According to IEC 60947-3/VDE 0660 part 107 | | | | |
|-------------|---|---|--------------------------------------|--|------|------|
| | | Insulation Voltage ¹ U_i V | Thermal Current I_u/I_{th} A | Motor Rating 3 x 380 V-440 V AC-23 AC-3 | | |
| | | | | kW | kW | |
| S00 |  | CA4 | 440 | 10 | 3 | 2,2 |
| | | CA4-1 | 440 | 10 | 3 | 2,2 |
| | | CAD4-1 | 440 | 5 | - | - |
| S0 |  | CA10 | 690 | 20 | 7,5 | 5,5 |
| | | CA11 | 690 | 20 | 7,5 | 5,5 |
| | | CA20 | 690 | 25 | 11 | 7,5 |
| | | CA25 | 690 | 32 | 15 | 11 |
| | | CAD11 | 600 | 6 | - | - |
| | | CAD12 | 600 | 6 | - | - |
| S1 |  | CA10B | 690 | 20 | 7,5 | 5,5 |
| | | CA11B | 690 | 20 | 7,5 | 5,5 |
| | | CA20B | 690 | 25 | 11 | 7,5 |
| | | CA25B | 690 | 32 | 15 | 11 |
| | | C26 | 690 | 32 | 15 | 11 |
| | | C32 | 690 | 50 | 22 | 15 |
| | | C42 | 690 | 63 | 30 | 18,5 |
| | | CA40 | 690 | 40 | 18,5 | 15 |
| | | CA50 | 690 | 50 | 22 | 18,5 |
| | | CA63 | 690 | 63 | 30 | 18,5 |
| S2 |  | C43 | 690 | 63 | 30 | 18,5 |
| | | C80 | 690 | 115 | 45 | 30 |
| | | C125 | 690 | 150 | 75 | 37 |
| | | C200-4 | 690 | 200 | 75 | 37 |
| | | L350 | 690 | 350 | 90 | 37 |
| | | L351 | 690 | 350 | 90 | 37 |
| | | L630 | 690 | 630 ² | 90 | 37 |
| | | L631 | 690 | 630 ² | 90 | 37 |
| | | L1000 | 690 | 1000 ² | 90 | 37 |
| | S3 |  | C315 | 690 | 315 | 132 |
| | | C316³ | 1000 | 315 | 132 | 55 |
| | | L400 | 690 | 500 | 132 | 55 |
| | | L600 | 690 | 800 ² | 132 | 55 |
| | | L800 | 690 | 1100 ² | 132 | 55 |
| | | L1200 | 690 | 1450 ² | 132 | 55 |
| | | L1600 | 690 | 1900 ² | 132 | 55 |
| | L2000 | 690 | 2400 ² | 132 | 55 | |

For further technical details, refer to pages 44-47.
To furnish with gold contacts and quick connects see page 6.

¹Valid for lines with grounded common neutral termination, overvoltage category III, pollution degree 3. Values for other supply systems on request. ²Ambient temperature 35 °C max. ³Additional switch functions on request.

How to order

Disconnectors and Main Switches according to IEC 60947-3 see Catalog 500

Three types of data (shown below) are required for ordering Blue Line cam-operated switches. Code numbers for ordering are shown in this catalog.

1. Type of Switch

The type of switch required may be easily selected by referring to the table on page 5 which shows the thermal current, power rating and dimensions of each switch. For further technical details, refer to pages 44-47. Variations of contacts and terminals are shown below.

2. Switch Function

The code numbers for standard switches shown on pages 8-32 indicate the switch function, face plate, handle and any optional extras.

Additional coding to modify type and color of handle and face plate is explained below.

3. Type of Mounting

Types of mounting are shown on pages 33-39. Catalog **101** describes enclosures and optional extras.

Specify the mounting code to indicate required mounting.

CA10

A202

VE

Type of Switch

Extending the switch type coding the following combinations will define:

| Amendment | Definition | For switch types |
|----------------|---|---|
| -1 | with gold contacts ¹ | CA4-1, CA4N-1, CA10-1, CA11-1, CA10B-1, CA11B-1, CAD4-1 |
| -4 | with quick connects | CA4-4 |
| B ² | S0 switches with latching mechanism size S1 | CA10B, CA11B, CA25B, CAD11B, CAD12B |
| C ² | S1 switches with latching mechanism size S2 | CA40C, CA50C, CA63C |
| L | with lockout-relay w/o manual release for std. sw. | CA10L, C25L, C26L, CA40L, CA50L, CA63L |
| M | with lockout-relay with manual release for std. sw. | CA10M, C25M, C26M, C42M, CA40M, CA50M, CA63M |
| X | with power failure release | CA10X, CA20X, CA25X, C26X, C32X, C42X, CA40X, CA50X, CA63X |
| Y | with power failure release and trip-free release | CA10Y, CA20Y, CA25Y |
| S ² | with snap action | CA10S, CA20S, CA25S with 60° or 90° switching C26S, C32S, C42S, CA40S, CA50S, CA63S with 60° switching |
| R | with spring return latching mechanism | CA10R, CA25R, CAD11R, CAD12R |

Example: Coding for switch type **CA10** with gold contacts is **CA10-1**.

Handles, Face Plates and Optional Extras

The handles for standard switches shown on pages 8-32 are suitable for mounting units with four hole mounting. Alternative types of handles available are illustrated on page 42, and mounting units on pages 31-37.

When a handle, face plate or optional extra is required but not covered by the dash number, the code number for the selected component should be entered separately. A comprehensive range of available standard face plates is illustrated on pages 40 and 41. Non-standard or special face plate engravings are available at extra cost.

The large number of optional extras and enclosures is covered in Catalog **101**.

Switch Size

Blue Line switches are available in sizes S00, S0, S1, S2 and S3. These size codes indicate the dimensions of the mounting, the face plate and the handle, as well as the size of optional devices and enclosures.

Page 5 lists these sizes and the various switch types they include.

¹Technical data on request. ²Additional length for switches with B, C, S, amendments refer page 54.

How to order

Ordering of Special Switches and Face Plates

When ordering special switches and face plates it is advisable to use our order form, as illustrated. The customer's requirements are shown in blue as an example.

For technical reasons, it may not be possible to follow the sequence of contacts requested by the customer. The final contact development which is sent with every switch will show the customer's original terminal markings.

| ESCUTCHEON PLATE | TERMINALS | | | | | | | | | | | | | | | | | | | | | | | | | | | | | | | | | | | | | | | | | | | | | | | | SWITCH-TYPE | MOUNTING | FIRM | | | | | | | | | | | | | | | | | | | | | | | | | | | | | |
|------------------|-----------|---|---|---|----|----|----|----|----|----|----|----|----|----|----|----|----|----|----|----|----|----|----|----|--------|----|--------|--|--|--|--|--|--|--|--|--|-------------------|--|------|--|--|--|--|--|--|--|--|--|-------------|----------|------|--|--|--|--|--------|--|--|--|--|--|--|--|--|--|--|--|----------|--|--|--|--|--|--|--|--|--|--|--|--|
| MOTOR 1 | 1 | 2 | 3 | 4 | 5 | 7 | 9 | 11 | 13 | 15 | 17 | 19 | 21 | 23 | 25 | 27 | 29 | 31 | 33 | 35 | 37 | 39 | 41 | 43 | 45 | 47 | : CAZ0 | | | | | | | | | | | | : VE | | | | | | | | | | | | : | | | | | | | | | | | | | | | | | | | | | | | | | | | | | |
| | 2 | 4 | 6 | 8 | 10 | 12 | 14 | 16 | 18 | 20 | 22 | 24 | 26 | 28 | 30 | 32 | 34 | 36 | 38 | 40 | 42 | 44 | 46 | 48 | : G001 | | | | | | | | | | | | : M004/02 1A 0 60 | | | | | | | | | | | | : | | | | | | | | | | | | | | | | | | | | | | | | | | | | | | | |
| POSITIONS | | | | | | | | | | | | | | | | | | | | | | | | | | | | | | | | | | | | | | | | | | | | | | | | | | | | | | | | DATE : | | | | | | | | | | | | SIGNED : | | | | | | | | | | | | |
| O | | | | | | | | | | | | | | | | | | | | | | | | | | | | | | | | | | | | | | | | | | | | | | | | | | | | | | | | | | | | | | | | | | | | | | | | | | | | | | | | |
| H | | x | | x | | | | | | | | x | | | | | | | | | | | | | | | | | | | | | | | | | | | | | | | | | | | | | | | | | | | | | | | | | | | | | | | | | | | | | | | | | | | | |
| A | | | | x | | x | | | | | | | | x | | | | | | | | | | | | | | | | | | | | | | | | | | | | | | | | | | | | | | | | | | | | | | | | | | | | | | | | | | | | | | | | | | |

Order forms are available on request.

[< back to table of contents >](#)

Notes:

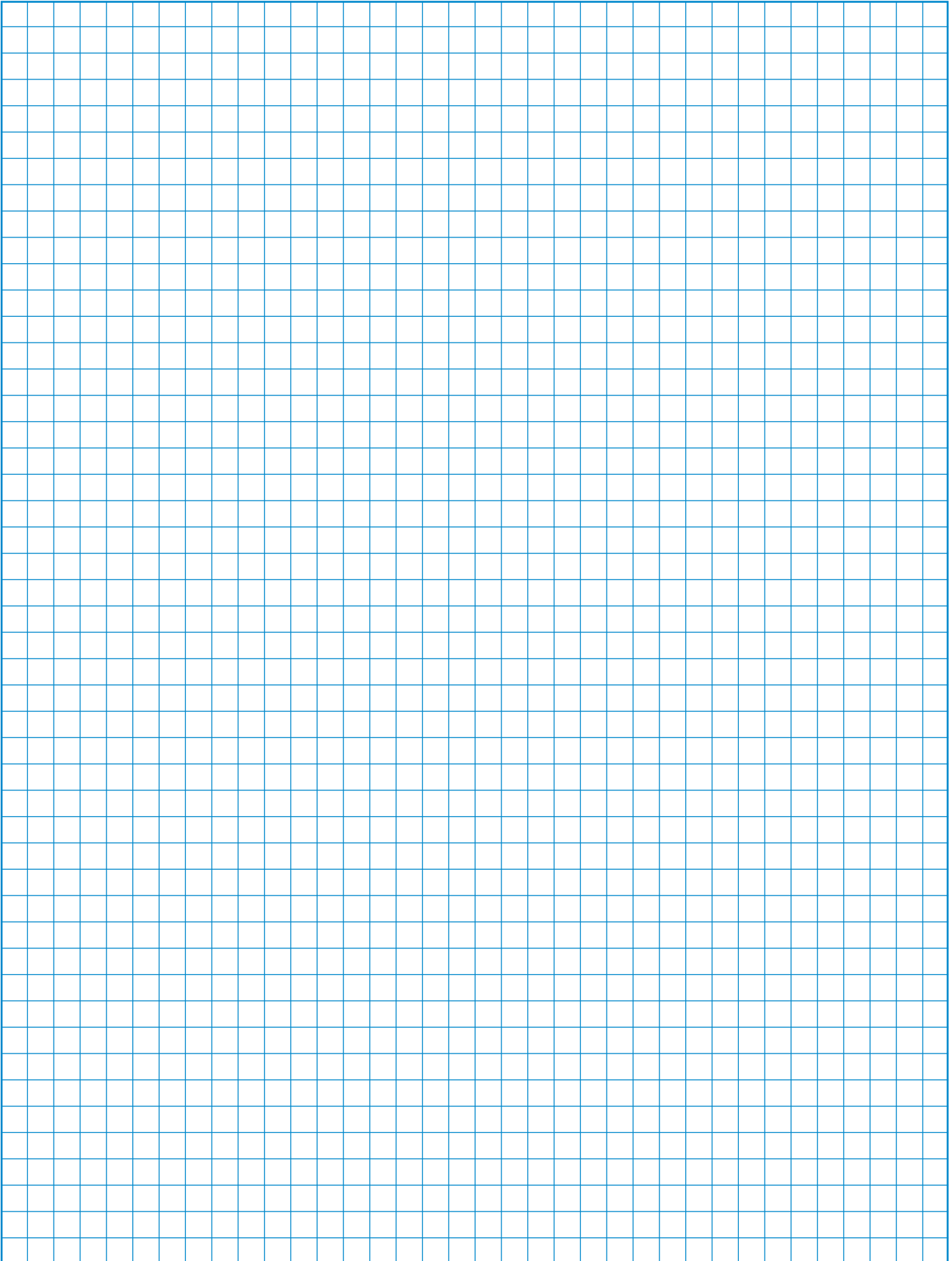













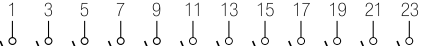











































[< back to table of contents >](#)

| Function | Escutch. Plate | Type/Handle | | | | Code | Stages | Connection Diagram |
|----------|----------------|------------------------|------------------------|-----------------|----------------------|------|--------|--------------------|
| | | CA4 CA4-1 CAD4-1 | CAD.. CA10- CA25 | CA10B- CA25B | CA40 C26- C315 | | | |















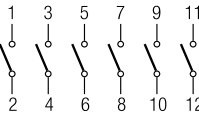





















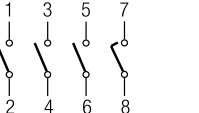

ON/OFF Switches with 60° Switching

[Dimensions p.56](#)



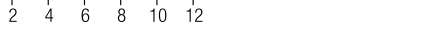











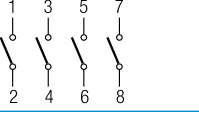

















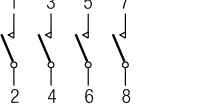

| | | | | | | | | |
|--|--|---|---|---|---|--------|---|---|
| 1 pole |  F070 |  |  |  |  | A200 | 1 |  |
| 2 pole | |  |  |  |  | A201 | 1 | |
| 3 pole | |  |  |  |  | A202 | 2 | |
| 4 pole | |  |  |  |  | A203 | 2 | |
| 4 pole 1 pole preclose 6° ¹ | |  |  |  |  | WAA653 | 2 | |
| 5 pole | |  |  |  |  | WAA341 | 3 | |
| 6 pole | |  |  |  |  | A342 | 3 | |
| 7 pole | |  |  |  |  | A343 | 4 | |
| 8 pole | |  |  |  |  | A344 | 4 | |
| 8 pole 2 pole preclose 6° ¹ | |  |  |  |  | WAA654 | 4 | |
| 9 pole | |  |  |  |  | WAA345 | 5 | |
| 10 pole | |  |  |  |  | A346 | 5 | |
| 11 pole |  |  |  |  | WAA347 | 6 | | |
| 12 pole |  |  |  |  | A348 | 6 | | |

ON/OFF Switches with 90° Switching

[< back to table of contents >](#)

| | | | | | | | | |
|---|--|---|---|---|---|--------|---|---|
| 1 pole contacts |  F066 |  |  |  |  | A290 | 1 |  |
| 2 pole preclose 30° | |  |  |  |  | A291 | 1 | |
| 3 pole | |  |  |  |  | A292 | 2 | |
| 4 pole | |  |  |  |  | A324 | 2 | |
| 4 pole 1 pole preclose 60° ¹ | |  |  |  |  | A293 | 2 | |
| 4 pole 3 pole preclose 30° | |  |  |  |  | WAA327 | 2 | |
| 5 pole contacts |  F062 |  |  |  |  | WAA325 | 3 |  |
| 6 pole preclose 30° | |  |  |  |  | A326 | 3 | |
| 3 pole 360° rotation | |  |  |  |  | WAA208 | 2 | |

ON/OFF Switches with 30° Switching







































































| | | | | | | | | |
|---------------------------|--|---|---|---|---|--------|---|---|
| 1 pole |  F169 |  |  |  |  | WAA100 | 1 |  |
| 2 pole | |  |  |  |  | WAA101 | 1 | |
| 3 pole | |  |  |  |  | WAA102 | 2 | |
| 4 pole | |  |  |  |  | WAA103 | 2 | |
| 1 pole with spring return |  F153 |  |  |  |  | A204 | 1 |  |
| 2 pole with spring return | |  |  |  |  | A205 | 1 | |
| 3 pole with spring return | |  |  |  |  | WAA206 | 2 | |
| 4 pole with spring return | |  |  |  |  | WAA207 | 2 | |

¹for use in a three phase four-wire system with switched neutral ²not available for switch type CA25 ³not available for switch type C315

| Function | Escutch. Plate | Type/Handle | | | | Code | Stages | Connection Diagram |
|----------|----------------|------------------------|------------------------|-----------------|----------------------|------|--------|--------------------|
| | | CA4 CA4-1 CAD4-1 | CAD.. CA10- CA25 | CA10B- CA25B | CA40 C26- C315 | | | |































Double-throw Switches without „OFF“ 60° Switching

[Dimensions p.56](#)





































| | | | | | | | | |
|--|---|---|---|---|---|--------|---|---|
| 1 pole |  F072 |  |  |  |  | A220 | 1 |  |
| 2 pole | |  |  |  |  | A221 | 2 |  |
| 3 pole | |  |  |  |  | A222 | 3 |  |
| 4 pole | |  |  |  |  | A223 | 4 |  |
| 4 pole 1 pole preclose 6° ² | |  |  |  |  | WAA673 | 4 |  |
| 5 pole | |  |  |  |  | A369 | 5 |  |
| 6 pole | |  |  |  |  | A370 | 6 |  |
| 7 pole | |  |  |  |  | A371 | 7 |  |
| 8 pole | |  |  |  |  | A372 | 8 |  |
| 8 pole 2 pole preclose 6° ² | |  |  |  |  | WAA972 | 8 |  |
| 9 pole | |  |  |  |  | WAA373 | 9 |  |
| 10 pole | |  |  |  |  | WAA374 | 10 |  |
| 11 pole |  |  |  |  | WAA375 | 11 |  | |
| 12 pole |  |  |  |  | WAA376 | 12 |  | |

[< back to table of contents >](#)

Double-throw Switches without „OFF“ with electrically isolated contacts

| | | | | | | | | |
|--|---|---|---|---|---|--------|---|---|
| 1 pole |  F072 |  |  |  |  | A720 | 1 |  |
| 2 pole | |  |  |  |  | A721 | 2 |  |
| 3 pole | |  |  |  |  | A722 | 3 |  |
| 4 pole | |  |  |  |  | A723 | 4 |  |
| 4 pole 1 pole preclose 6° ² | |  |  |  |  | WAA973 | 4 |  |
| 1 pole with spring return |  F026 |  |  |  | | A795 | 1 |  |

Double-throw Switches without „OFF“ 30° Switching















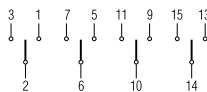



























| | | | | | | | | |
|---------------------------|---|---|---|---|---|--------|---|---|
| 1 pole |  F026 |  |  |  |  | WAA120 | 1 |  |
| 2 pole | |  |  |  |  | WAA121 | 2 |  |
| 3 pole | |  |  |  |  | WAA122 | 3 |  |
| 4 pole | |  |  |  |  | WAA123 | 4 |  |
| 1 pole with spring return |  F026 |  |  |  |  | A295 | 1 |  |
| 2 pole with spring return | |  |  |  |  | A296 | 2 |  |
| 3 pole with spring return | |  |  |  |  | WAA297 | 3 |  |

¹not available for switch type CA25 ²for use in a three phase four-wire system with switched neutral

| Function | Escutch. Plate | Type/Handle | Code | Stages | Connection Diagram |
|----------|----------------|---|------|--------|--------------------|
| | | CA4 CAD.. CA4-1 CA10- CA10B- C80- CAD4-1 CA25 CA63 C315 | | | |



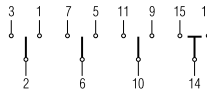
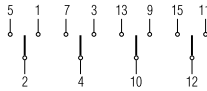
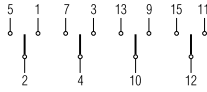

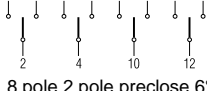













Double-throw Switches with Center „OFF“ 60° Switching

[Dimensions p.56](#)































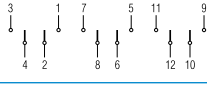

| | | | | | | | | |
|--|---|---|---|---|---|--------|---|--|
| 1 pole |  <p>F071</p> |  |  |  |  | A210 | 1 |  <p>1-4 pole</p> |
| 2 pole | |  |  |  |  | A211 | 2 | |
| 3 pole | |  |  |  |  | A212 | 3 | |
| 4 pole | |  |  |  |  | A213 | 4 | |
| 4 pole 1 pole preclose 6° ³ | |  |  |  |  | WAA913 | 4 | |
| 5 pole | |  |  |  |  | A361 | 5 | |
| 6 pole | |  |  |  |  | A362 | 6 | |
| 7 pole | |  |  |  |  | WAA363 | 7 | |
| 8 pole | |  |  |  |  | WAA364 | 8 | |
| 8 pole 2 pole preclose 6° ³ |  |  |  |  | WAA664 | 8 | | |
| | | | | | | | |  <p>4 pole 1 pole preclose 6°</p> |
| | | | | | | | |  <p>5 pole</p> |
| | | | | | | | |  <p>6 and 7 pole</p> |
| | | | | | | | |  <p>8 pole</p> |
| | | | | | | | |  <p>8 pole 2 pole preclose 6°</p> |

[< back to table of contents >](#)

Double-throw Switches with Center „OFF“ 90° Switching

| | | | | | | | | |
|---|---|---|---|---|---|--------|---|---|
| 1 pole |  <p>F057</p> |  |  |  |  | A218 | 1 |  <p>1-4 pole</p> |
| 2 pole | |  |  |  |  | A219 | 2 | |
| 3 pole | |  |  |  |  | WAA299 | 3 | |
| 4 pole 1 pole preclose 60° ³ | |  |  |  |  | WAA294 | 4 | |

Double-throw Switches with Center „OFF“ and electrically isolated contacts













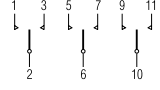

| | | | | | | | | |
|--|---|---|---|---|---|------|--|---|
| 1 pole |  <p>F071</p> |  |  |  |  | A710 | 1 |  <p>1-4 pole</p> |
| 2 pole | |  |  |  |  | A711 | 2 | |
| 3 pole | |  |  |  |  | A712 | 3 | |
| 4 pole 1 pole preclose 6° | |  |  |  |  | A713 | 4 | |
| 4 pole 1 pole preclose 6° ³ |  |  |  |  | WAA963 | 4 |  <p>4 pole 1 pole preclose 6°</p> | |
| 1 pole with spring return to center |  <p>F025</p> |  |  |  |  | A714 | 1 |  <p>1 and 2 pole</p> |
| 2 pole | |  |  |  |  | A715 | 2 | |

¹switch type C315 with  handle ²not available for switch type C315 ³for use in a three phase four-wire system with switched neutral















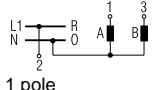
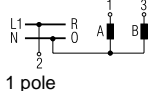
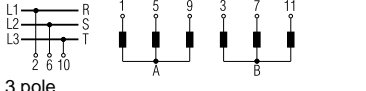
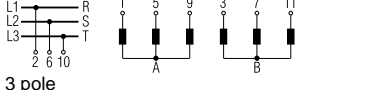

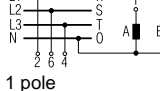
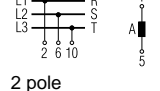
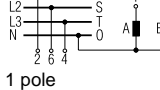
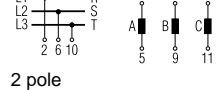
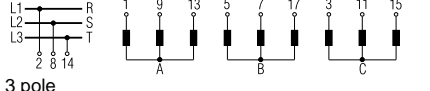

| Function | Escutch. Plate | Type/Handle | Code | Stages | Connection Diagram |
|----------|----------------|--|------|--------|--------------------|
| | | CA4 CAD.. CA40 CA4-1 CA10- C26- CAD4-1 CA25 CA25B C315 | | | |

Double-throw Switches with Spring Return to Center

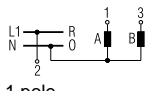
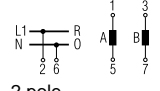
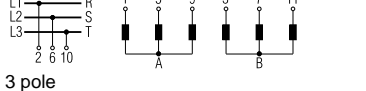
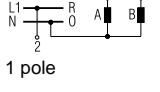
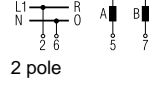
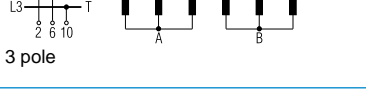
[Dimensions p.56](#)

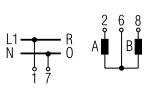
| | | | | | | |
|---|---|---|--|----------------------|-------------|---|
| 1 pole with spring return 2 pole to center 3 pole |  F025 |    |  ²  ³ | A214 A215 A216 | 1 2 3 |  1-3 pole |
| 1 pole with spring return 2 pole from left to center 3 pole |  F261 |    |  ¹  | A320 A321 A322 | 1 2 3 |  1-3 pole |

General Application Switches

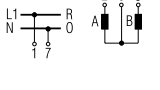
| | | | | | | |
|---|---|---|--|----------------------------|-------------|---|
| 1 pole 2 Gang 2 pole Switching sequence: 3 pole 0, A, A+B |  F075 |    |   | A310 A312 WAA314 | 1 2 3 |  1 pole  2 pole  3 pole |
| 1 pole 3 Gang 2 pole Switching sequence: 3 pole 0, A, A+B, A+B+C |  F001 |    |   | A311 WAA313 WAA315 | 2 3 5 |  1 pole  2 pole  3 pole |
| 1 pole 2 Gang 2 pole Series switching 3 pole Switching sequence: 0, A, B, A+B |  F001 |    |   | WAA330 WAA331 WAA332 | 1 2 3 |  1 pole  2 pole  3 pole |
| 2 pole 2 Gang Series-parallel Switching Switching sequence: 0, A+B series, A, A+B parallel |  F001 |    |   | WAA339 | 2 |  |

[< back to table of contents >](#)













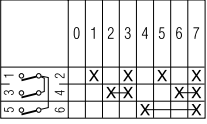



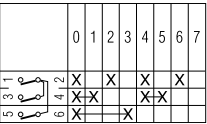



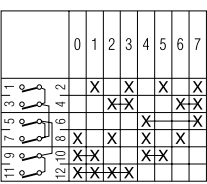



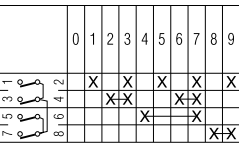



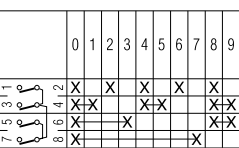

¹not available for switch type CA25 ²not available for switch type C315 ³available only up to switch type CA63

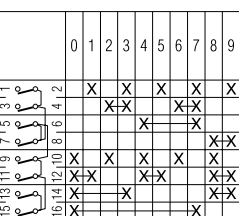
| Function | Escutch. Plate | Type/Handle | | | | Code | Stages | Connection Diagram |
|----------|----------------|------------------------|----------------------|-----------------|----------------------|------|--------|--------------------|
| | | CA4 CA4-1 CAD4-1 | CA10 CA11 CA12 | CA10B- CA25B | CA40 C26- C315 | | | |

Coding Switches/Binary Code

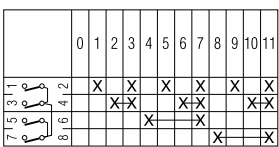
[Dimensions p.56](#)

< back to table of contents >

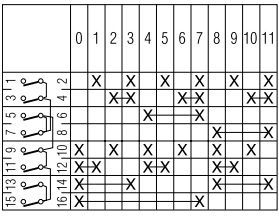
| | | | | | | | |
|--------------------------------------|---|---|---|--|--------|---|---|
| 0 - 7 360° rotation |  F322 |  |  | | A540 | 2 |  |
| 0 - 7 complement 360° rotation |  F322 |  |  | | WAA541 | 2 |  |
| 0 - 7 + complement 360° rotation |  F322 |  |  | | WAA542 | 3 |  |
| 0 - 9 |  F007 |  |  | | A550 | 2 |  |
| 0 - 9 complement |  F007 |  |  | | WAA551 | 2 |  |
| 0 - 9 + complement |  F007 |  |  | | WAA552 | 4 |  |
| 0 - 11 360° rotation |  F009 |  |  | | A543 | 2 |  |
| 0 - 11 + complement 360° rotation |  F009 |  |  | | WAA545 | 4 |  |















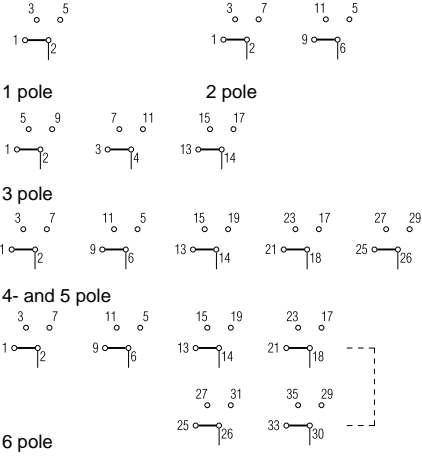





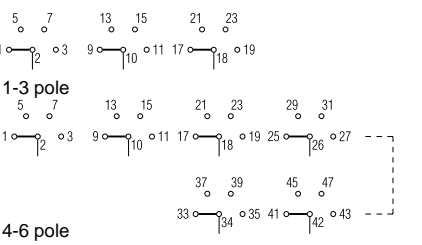





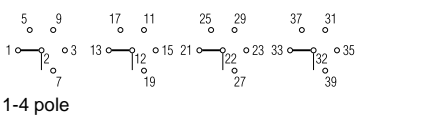





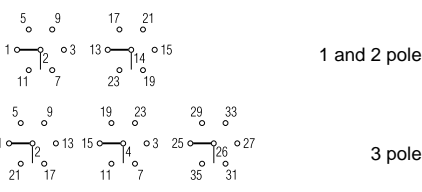





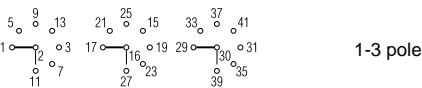





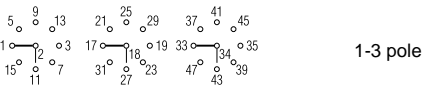













Switch Function and Configuration

C, CA, CAD Switches

| Function | Escutch. Plate | Type/Handle CA4 CAD.. CA4-1 CA10- CA10B- C80- CAD4-1 CA25 CA63 C315 | Code | Stages | Connection Diagram |
|----------|----------------|--|------|--------|--------------------|
|----------|----------------|--|------|--------|--------------------|

Multi-step Switches without „OFF“

Dimensions p. 56

| | | | | | | | | |
|---|---|---|---|---|---|--|------------------------------|---|
| 1 pole 3 Step 2 pole 3 pole 4 pole 5 pole 6 pole |  F076 |  |  |  |  | A230 A250 A270 A476 WAA484 WAA489 | 2 3 5 6 8 9 |  |
| 1 pole 4 Step 2 pole 3 pole 4 pole 5 pole 6 pole |  F077 |  |  |  |  | A231 A251 A271 A477 WAA485 WAA490 | 2 4 6 8 10 12 |  |
| 1 pole 5 Step 2 pole 3 pole 4 pole |  F078 |  |  |  |  | A232 A252 WAA272 WAA478 | 3 5 8 10 |  |
| 1 pole 6 Step 2 pole 3 pole |  F079 |  |  |  |  | A233 WAA253 WAA273 | 3 6 9 |  |
| 1 pole 7 Step 2 pole 3 pole |  F110 |  |  |  |  | WAA234 WAA254 WAA274 | 4 7 11 |  |
| 1 pole 8 Step 2 pole 3 pole |  F111 |  |  |  |  | WAA235 WAA255 WAA275 | 4 8 12 |  |
| 1 pole 9 Step |  F10 |  |  |  |  | WAA236 | 5 |  |
| 1 pole 10 Step |  F101 |  |  |  |  | WAA237 | 5 |  |
| 1 pole 11 Step |  F012 |  |  |  |  | WAA238 | 6 |  |
| 1 pole 12 Step 1 pole 360° rotation |  F013 |  |  |  |  | WAA239 WAA639 | 6 6 |  |

¹switch type C315 with  handle ²not available for switch type CA11B

| Function | Escutch. Plate | Type/Handle | Code | Stages | Connection Diagram |
|----------|----------------|---|------|--------|--------------------|
| | | CA4 CAD.. CA4-1 CA10- CA10B- C80- CAD4-1 CA25 CA63 C315 | | | |

Multi-step Switches without „OFF“ with electrically isolated contacts [Dimensions p.56](#)

| | | | | | | | | |
|---------------|--|--|--|--|--|------|---|------------|
| 1 pole 3 Step | | | | | | A730 | 2 | 1 pole |
| 2 pole | | | | | | A750 | 3 | 2 pole |
| 1 pole 4 Step | | | | | | A731 | 2 | 1 pole |
| 2 pole | | | | | | A751 | 4 | 2 pole |

Multi-step Switches with „OFF“















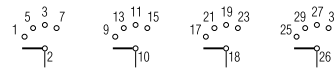





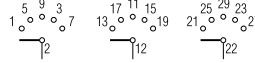





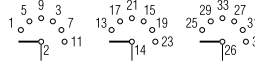





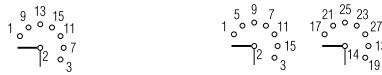













| | | | | | | | | |
|---|--|--|--|--|--|--|----------------------------|--|
| 1 pole 2 Step 2 pole 3 pole 4 pole 5 pole 6 pole | | | | | | A240 A260 A280 WAA480 WAA486 WAA491 | 1 2 3 4 5 6 | 1-6 pole |
| 1 pole 3 Step 2 pole 3 pole 4 pole 5 pole | | | | | | A241 A261 A281 WAA481 WAA487 | 2 3 5 6 8 | 1 and 2 pole 3 pole 4 pole 5 pole |

[< back to table of contents >](#)

| Function | Escutch. Plate | Type/Handle | | | | Code | Stages | Connection Diagram |
|----------|----------------|------------------------|-----------------------|----------------|--------------|------|--------|--------------------|
| | | CA4 CA4-1 CAD4-1 | CAD. CA10- CA25 | CA10B- CA63 | C80- C315 | | | |

Multi-step Switches with „OFF“

[Dimensions p. 56](#)

| | | | | | | | | |
|---|---|---|---|---|---|------------------------------------|------------------|---|
| 1 pole 4 Step 2 pole 3 pole 4 pole |  F002 |  |  |  |  | A242 WAA262 WAA282 WAA482 | 2 4 6 8 |  1-4 pole |
| 1 pole 5 Step 2 pole 3 pole |  F003 |  |  |  |  | A243 WAA263 WAA283 | 3 5 8 |  1-3 pole |
| 1 pole 6 Step 2 pole 3 pole |  F004 |  |  |  |  | A244 WAA264 WAA284 | 3 6 9 |  1-3 pole |
| 1 pole 7 Step 2 pole |  F005 |  |  |  |  | WAA245 WAA265 | 4 7 |  1 pole 2 pole |
| 1 pole 8 Step |  F006 |  |  |  |  | WAA246 | 4 |  |
| 1 pole 9 Step |  F007 |  |  |  |  | WAA247 | 5 |  |
| 1 pole 10 Step |  F008 |  |  |  |  | WAA248 | 5 |  |
| 1 pole 11 Step 1 pole 360° rotation |  F009 |  |  |  |  | WAA249 WAA649 | 6 6 |  |

[< back to table of contents >](#)









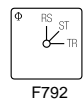

Switch Function and Configuration

C, CA, CAD Switches



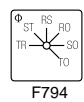



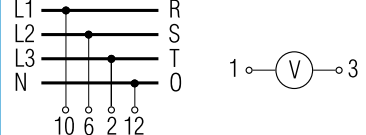



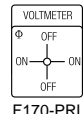

| Function | Escutch. Plate | Type/Handle | Code | Stages | Connection Diagram |
|----------|----------------|---|-----------------|--------|--------------------|
| | | CA4 CA4-1 CA10- CAD4-1 CA25 CAD.. | CA10B- CA25B | | |

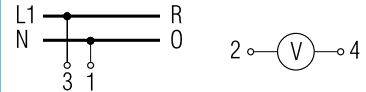
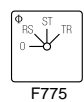
Voltmeter Switches without „OFF“

[Dimensions p.56](#)

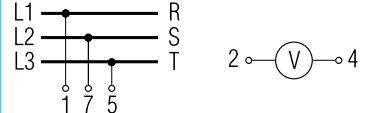
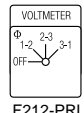
| | | | | | | | | |
|--|---|---|---|---|---|------|---|---|
| 3 phase 3 wire |  F792 |  |  |  |  | A023 | 2 |  |
| 3 phase 3 wire 3 phase to phase and phase to neutral |  F794 |  |  |  |  | A025 | 3 |  |

Voltmeter Switches with „OFF“

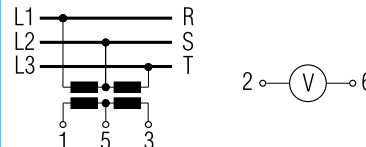













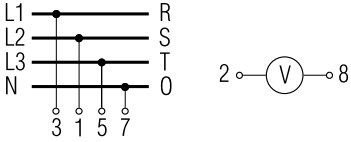





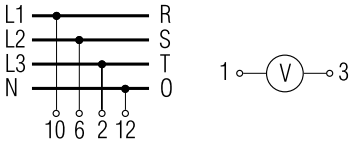

| | | | | | | | | |
|-------------------------|---|---|---|---|---|--------|---|---|
| 2 pole 360° rotation |  F170-PRL |  |  |  |  | WAA002 | 1 |  |
| 3 phase 3 wire |  F775 |  |  |  |  | A004 | 2 |  |
| |  F212-PRL |  |  |  |  | WAA011 | 2 |  |

[< back to table of contents >](#)

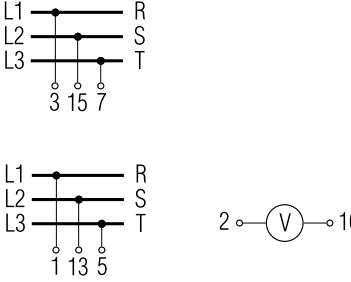
| Function | Escutch. Plate | Type/Handle | | | | Code | Stages | Connection Diagram |
|----------|----------------|------------------------|---------------|-------|-----------------|------|--------|--------------------|
| | | CA4 CA4-1 CAD4-1 | CA10- CA25 | CAD.. | CA10B- CA25B | | | |

Voltmeter Switches with „OFF“

[Dimensions p.56](#)

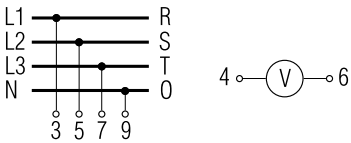









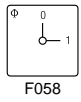



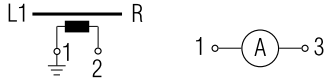
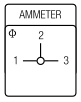



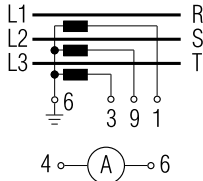



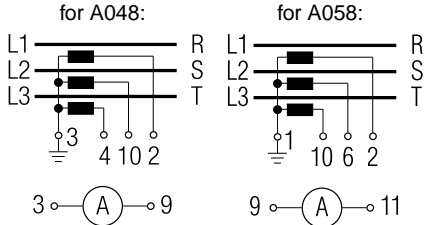
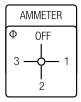

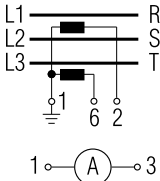
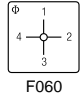

| | | | | | | | | |
|---|---|---|---|---|---|--------|---|---|
| 3 phase to neutral |  F779 |  |  |  |  | WAA005 | 2 |  |
| 3 phase to phase and 3 phase to neutral |  F782 |  |  |  |  | A007 | 3 |  |
| 2 separate 3 phase with center „OFF“ |  F786 |  |  |  |  | WAA008 | 4 |  |
| 3 phase and 1 phase to neutral |  F789 |  |  |  |  | WAA010 | 3 |  |

[< back to table of contents >](#)

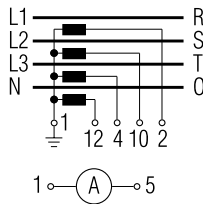
| Function | Escutch. Plate | Type/Handle | Code | Stages | Connection Diagram |
|----------|------------------------|------------------------|-----------------------|--------------|--------------------|
| | CA4 CA4-1 CAD4-1 | CAD.. CA10- CA25 | CA10B- CA63 C32 | C43- C125 | |

Ammeter Switches

[Dimensions p.56](#)

| | | | | | | | | |
|--|---|---|---|---|---|--------------|--------|---|
| Single pole with one current transformer |  F058 |  |  |  |  | WAA046 | 1 |  |
| Single pole with 3 current transformers without „OFF“ |  F181-PRL |  |  |  | | WAA017 | 3 |  |
| Single pole with 3 current transformers with „OFF“ 360° rotation |  F059 |  |  |  | | A048 A058 | 3 3 |  |
| Single pole with 2 current transformers (3 readings) |  F172-PRL |  |  |  |  | WAA021 | 2 |  |
| Single pole with 4 current transformers |  F060 |  |  |  |  | WAA036 | 4 |  |
| 2 pole 2 current transformers |  F057 |  |  |  | | WAA037 | 3 |  |

[< back to table of contents](#) [^](#)

¹available only up to switch type CA25B











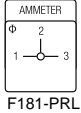

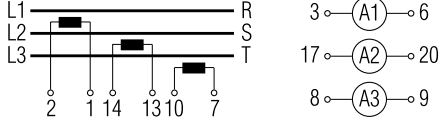

Switch Function and Configuration

C, CA, CAD Switches

| Function | Escutch. Plate | Type/Handle | Code | Stages | Connection Diagram |
|----------|----------------|--|------|--------|--------------------|
| | | CA4 CAD.. CA10B- CA4-1 CA10- CA63- CAD4-1 CA25 C42 C43- C125 | | | |

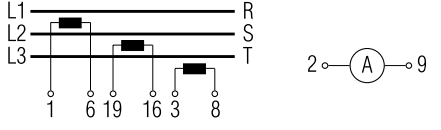
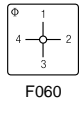
Ammeter Switches

[Dimensions p. 56](#)

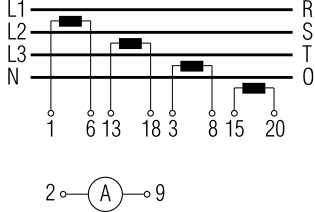





| | | | | | | | | | |
|----------------------------------|---|---|---|--|---|---------------|---------------|---|--|
| 2 pole 3 current transformers |  <p>F181-PRL</p> |  |  |  ¹ | | WAA019 | 5 |  | |
| |  <p>F059</p> |  |  |  |  | | A038 | 5 |  |
| 2 pole 4 current transformers |  <p>F060</p> |  |  |  |  | | WAA039 | 6 |  |

¹available only up to switch type CA25B

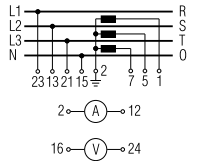
| Funktion | Switch- Bezeichnung | Type/Griff CA4 CA4-1 CAD.. CA10- CAD4-1 CA25 CA10B- CA25B | Code | Fluch- Stages ten | Anschlüsse Anschlüsse |
|----------|------------------------|--|------|-------------------------|--------------------------|
|----------|------------------------|--|------|-------------------------|--------------------------|

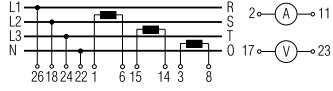

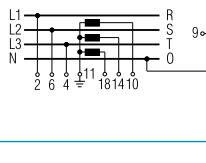

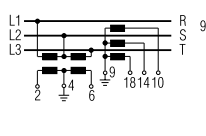



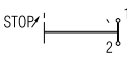

Volt-ammeter Switches

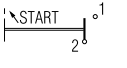
Dimensions p. 56

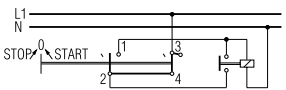
| | | | | | | | |
|--|---|--|--|---|--------|---|--|
| 3 phase - phase to phase 3 current |  F101 | | | | WAA027 | 6 |  |
| 3 phase voltage 3 phase current 4 wire |  F077 | | | 1 | WAA028 | 7 |  |
| 3 phase voltage 3 phase current 4 wire |  F174-PRL | | | 1 | WAA033 | 5 |  |
| 3 phase voltage 3 phase current 3 wire |  F174-PRL | | | 1 | WAA035 | 5 |  |

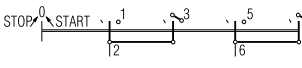
[back to table of contents >](#)

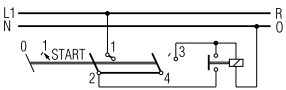
Control Switches

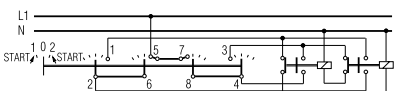









| | | | | | | | |
|---|---|--|--|---|--------|---|---|
| Stop switch |  F022 | | | 1 | WAA174 | 1 |  |
| Start switch |  F023 | | | 1 | A175 | 1 |  |
| Stop start switch single pole |  F024 | | | 1 | A176 | 1 |  |
| Stop start switch 2 pole |  F024 | | | 1 | WAA183 | 2 |  |
| Stop start switch with spring return from start to run |  F119 | | | 1 | A178 | 1 |  |
| Stop start switch with spring return to run for 2 units |  F121 | | | 1 | WAA177 | 2 |  |

¹available only up to switch type CA25B

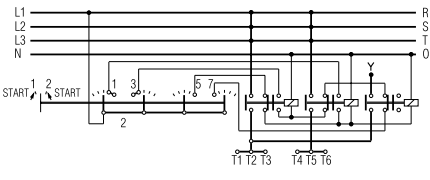













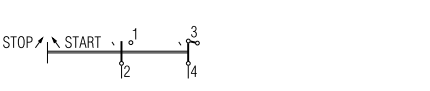





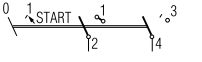



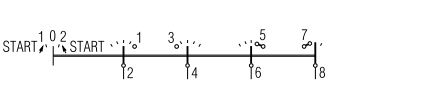

| Function | Escutch. Plate | Type/Handle | C26- C43 CA40- CA63 | Code | Stages | Connection Diagram |
|----------|----------------|---|---------------------|------|--------|--------------------|
| | | CA4 CAD.. CA4-1 CA10- CAD4-1 CA25 CA25B | | | | |

Control Switches



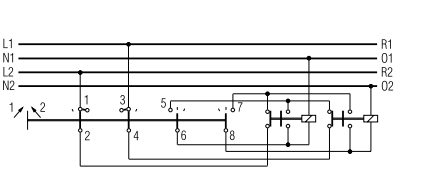

Dimensions p. 56

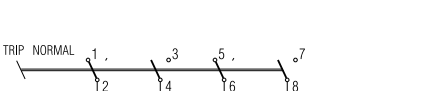
| | | | | | | | | |
|---|---|---|---|---|---|--------|---|---|
| Stop start switch with spring return to run with contactor interlock contactors for 2 units |  F121 |  |  |  |  | WAA182 | 2 |  |
| Motor voltage control switch |  F144-PRL |  |  |  | | WAA150 | 2 |  |

Control Switches with electrically isolated contacts

| | | | | | | | | |
|---|---|---|---|---|---|--------|---|---|
| Stop start switch single pole |  F024 |  |  |  |  | A789 | 1 |  |
| Stop start switch with spring return to 1 |  F119 |  |  |  |  | A791 | 1 |  |
| Stop start switch with spring return to run for 2 units |  F121 |  |  |  |  | WAA790 | 2 |  |
| Contactor control with spring return to „OFF“ |  F025 |  |  |  |  | WAA179 | 2 |  |
| Circuit breaker control |  F143-PRL |  |  |  | | WAA537 | 2 |  |

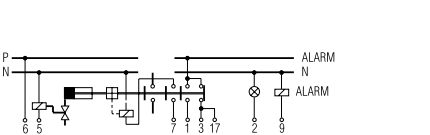
Control and Alarm Switches¹

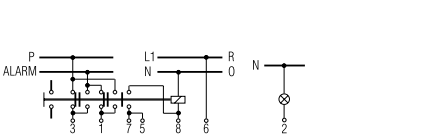
| | | | | | | | | |
|---|---|--|---|---|--|--------|----------------|---|
| With slip clutch and without indicator device |  | |  |  | | WAA190 | 5 ³ |  |
| Without indicator device |  | |  | | | WAA192 | 2 |  |

¹Advise the indicator device, described in Catalog 101, page 9. ²not available for switch types CA25 and CA25B ³incl. slip clutch ⁴available only up to switch type CA40

| Function | Escutch. Plate | Type/Handle | Code | Stages | Connection Diagram |
|----------|------------------------|-----------------------|---|--------|--------------------|
| | CA4 CA4-1 CAD4-1 | CAD. CA10- CA25 | CA..B C26-C43 CA40-CA63 C80- C315 | | |

Motor Reversing Switches

Dimensions p.56

| | | | | | | | | |
|--|--|--|--|--|--|--------|---|--|
| 2 pole | | | | | | A400 | 2 | |
| 3 pole | | | | | | A401 | 3 | |
| 3 pole with spring return to „OFF“ | | | | | | A228 | 3 | |
| 3 pole for use with reversing contactors | | | | | | WAA402 | 4 | |

< back to table of contents >

Motor Control Switches











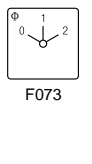

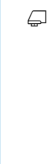

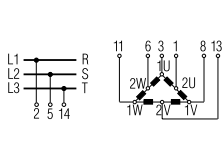
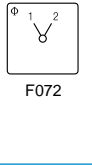

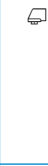

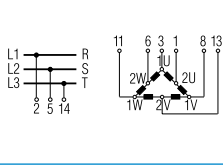
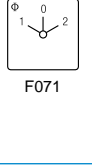

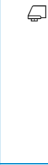

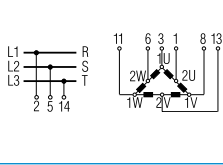
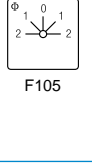

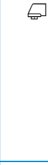
| | | | | | | | | |
|-------------------------------------|--|--|--|--|--|--------|---|--|
| 2 speed 2 winding 0-A-BY or Δ | | | | | | WAA451 | 3 | |
| 3 speed 2 winding 0-A-BY or Δ | | | | | | WAA457 | 6 | |

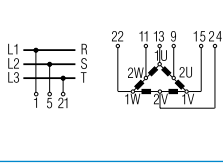
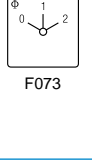
¹not available for switch type CA25 ²not available for switch types C26-C43, CA40-CA63 ³available only up to switch type CA50

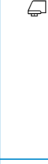
| Function | Escutch. Plate | Type/Handle | Code | Stages | Connection Diagram |
|----------|----------------|--|------|--------|--------------------|
| | | CA4 CAD.. CA40 CA4-1 CA10- CA10B- CAD4-1 CA25 CA25B C315 | | | |

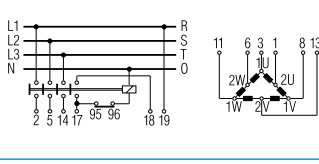
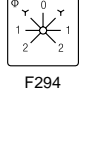
Motor Control Switches

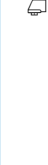
[Dimensions p.56](#)

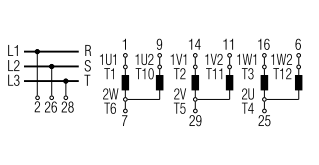
| | | | | | | | | |
|---|---|---|---|---|---|--------|-----------------|---|
| 2 speed single winding |  F073 |  |  |  |  | A440 | 4 |  |
| 2 speed single winding without „OFF“ |  F072 |  |  |  |  | A466 | 4 |  |
| 2 speed single winding with center „OFF“ |  F071 |  |  |  |  | A441 | 4 |  |
| 2 speed single winding reversing |  F105 |  |  |  |  | A442 | 6 |  |
| 2 speed single winding for use with contactors |  F073 |  |  |  |  | WAA444 | 5 |  |
| 2 speed reversing for 2 way operation with slip clutch for „OFF“ load use |  F294 |  |  |  |  | WAA468 | 10 ¹ |  |

¹incl. slip clutch

| Function | Escutch. Plate | Type/Handle | | | | Code | Stages | Connection Diagram |
|----------|----------------|------------------------|-----------------------|-------------------------------|--------------|------|--------|--------------------|
| | | CA4 CA4-1 CAD4-1 | CAD. CA10- CA25 | CA..B C26-C43 CA40-CA63 | C80- C315 | | | |

Star-delta Switches

[Dimensions p.56](#)

| | | | | | | | | |
|---|--|--|--|--|--|--------|---|--|
| OFF-star-delta | | | | | | A410 | 4 | |
| Reversing | | | | | | WAA413 | 5 | |
| With auxiliary contact closed in „OFF“ position | | | | | | WAA416 | 5 | |
| For use with reversing contactors | | | | | | A419 | 4 | |

[< back to table of contents >](#)

Start and Run Switches

| | | | | | | | | |
|--|--|--|--|--|--------------|--------|---|--|
| Split-phase start | | | | | | A425 | 2 | |
| Split-phase start reversing | | | | | ¹ | WAA426 | 3 | |
| Split-phase reversing auto cutout of start field winding | | | | | | WAA622 | 3 | |

¹not available for switch type CA25

| Function/Type | Escutch. Plate | Handle | Code | Stages | Double Latching | Connection Diagram | L350 L630 L1000 L1250 | L351 L631 L1001 L1251 |
|---------------|----------------|--------|------|--------|-----------------|--------------------|--------------------------------|--------------------------------|
|---------------|----------------|--------|------|--------|-----------------|--------------------|--------------------------------|--------------------------------|

ON/OFF Switches with 60° Switching

[Dimensions p. 56](#)

| | | | | | | | | |
|---|-------|--|--|--------------------------------------|-------------------|-------------|--|--------------|
| 1 pole 2 pole 3 pole 4 pole | L350 | | | WAA200 WAA201 WAA202 WAA203 | 1 2 3 4 | | | 1-4 pole |
| 1 pole 2 pole 3 pole 4 pole | L351 | | | WAA200 WAA201 WAA202 WAA203 | 1 2 3 4 | | | 1-4 pole |
| 1 pole 2 pole 3 pole 4 pole | L400 | | | WAA200 WAA201 WAA202 WAA203 | 2 2 4 4 | | | 1-4 pole |
| 3 pole with lugs suitable for protective cover | | | | WAA302 | 3 | | | A302 |
| 1 pole 2 pole 3 pole 4 pole | | | | WAA200 WAA201 WAA202 WAA203 | 2 2 4 4 | | | A302 |
| 1 pole 2 pole 3 pole 4 pole | L600 | | | WAA200 WAA201 WAA202 WAA203 | 3 3 6 6 | | | 1-4 pole |
| 1 pole 2 pole 3 pole 4 pole | L630 | | | WAA200 WAA201 WAA202 WAA203 | 2 4 6 8 | ● ● | | 1-4 pole |
| 1 pole 2 pole 3 pole 4 pole | L631 | | | WAA200 WAA201 WAA202 WAA203 | 2 4 6 8 | ● ● | | 1-4 pole |
| 1 pole 2 pole 3 pole 4 pole | L800 | | | WAA200 WAA201 WAA202 WAA203 | 2 4 6 8 | | | 1-4 pole |
| 1 pole 2 pole 3 pole 4 pole | L1000 | | | WAA200 WAA201 WAA202 WAA203 | 3 6 9 12 | ● ● ● | | 1-4 pole |
| 1 pole 2 pole 3 pole | L1200 | | | WAA200 WAA201 WAA202 | 3 6 9 | | | 1-3 pole |
| 1 pole 2 pole 3 pole | L1600 | | | WAA200 WAA201 WAA202 | 4 8 12 | | | 1-3 pole |
| 1 pole 2 pole | L2000 | | | WAA200 WAA201 | 5 10 | ● | | 1 und 2 pole |

[< back to table of contents >](#)

| Function/Type | Escutch. Plate | Handle | Code | Stages | Double Latching | Connection Diagram | L350 L630 L1000 L1250 | L351 L631 L1001 L1251 |
|---------------|----------------|--------|------|--------|-----------------|--------------------|--------------------------------|--------------------------------|
|---------------|----------------|--------|------|--------|-----------------|--------------------|--------------------------------|--------------------------------|

ON/OFF Switches with 90° Switching

[Dimensions p. 56](#)

| | | | | | | | | |
|--------------------------------------|---|--|--|--------------------------------------|-------------------|-------------|--|---------------|
| 1 pole 2 pole 3 pole 4 pole | L350 1 pole preclose 60° | | | WAA290 WAA291 WAA292 WAA293 | 1 2 3 4 | | | |
| 1 pole 2 pole 3 pole 4 pole | L351 1 pole preclose 60° | | | WAA290 WAA291 WAA292 WAA293 | 1 2 3 4 | | | |
| 1 pole 2 pole 3 pole 4 pole | L400 1 pole preclose 60° | | | WAA290 WAA291 WAA292 WAA293 | 2 2 4 4 | | | |
| 3 pole | with lugs suitable for protective cover | | | WAA307 | 3 | | | |
| 3 pole | 360° rotation | | | WAA208 | 4 | | | |
| 1 pole 2 pole 3 pole 4 pole | L600 1 pole preclose 60° | | | WAA290 WAA291 WAA292 WAA293 | 3 3 6 6 | | | |
| 1 pole 2 pole 3 pole 4 pole | L630 1 pole preclose 60° | | | WAA290 WAA291 WAA292 WAA293 | 2 4 6 8 | | | |
| 1 pole 2 pole 3 pole 4 pole | L631 1 pole preclose 60° | | | WAA290 WAA291 WAA292 WAA293 | 2 4 6 8 | | | |
| 1 pole 2 pole 3 pole 4 pole | L800 1 pole preclose 60° | | | WAA290 WAA291 WAA292 WAA293 | 2 4 6 8 | ● ● ● | | |
| 1 pole 2 pole 3 pole 4 pole | L1000 1 pole preclose 60° | | | WAA290 WAA291 WAA292 WAA293 | 3 6 9 12 | ● ● ● | | |
| 1 pole 2 pole 3 pole | L1200 | | | WAA290 WAA291 WAA292 | 3 6 9 | ● ● ● | | 1-3 pole |
| 1 pole 2 pole 3 pole | L1600 | | | WAA290 WAA291 WAA292 | 4 8 12 | ● ● ● | | 1-3 pole |
| 1 pole 2 pole | L2000 | | | WAA290 WAA291 | 5 10 | ● ● | | 1- und 2 pole |

< back to table of contents >

● Additional length for switches size S2 for mounting E/EF = 27 mm
 ● Additional length for switches size S3 for mounting E/EF = 31,5 mm and mounting ER/VE = 20,1 mm

Switch Function and Configuration

L Switches

| Function/Type | Escutch. Plate | Handle | Code | Stages | Double Latching | Connection Diagram | L350 L630 L1000 L1250 | L351 L631 L1001 L1251 |
|---------------|----------------|--------|------|--------|-----------------|--------------------|--------------------------------|--------------------------------|
|---------------|----------------|--------|------|--------|-----------------|--------------------|--------------------------------|--------------------------------|

Double-throw Switches without „OFF“ 60° Switching [Dimensions p. 56](#)

| | | | | | | | | |
|--------------------------------------|-------|--|--|--------------------------------------|-------------------|--------|--|--------------|
| 1 pole 2 pole 3 pole 4 pole | L350 | | | WAA220 WAA221 WAA222 WAA223 | 2 4 6 8 | | | 1-4 pole |
| 1 pole 2 pole 3 pole 4 pole | L351 | | | WAA220 WAA221 WAA222 WAA223 | 2 4 6 8 | | | 1-4 pole |
| 1 pole 2 pole 3 pole 4 pole | L400 | | | WAA220 WAA221 WAA222 WAA223 | 2 4 6 8 | | | 1-4 pole |
| 1 pole 2 pole 3 pole 4 pole | L600 | | | WAA220 WAA221 WAA222 WAA223 | 3 6 9 12 | ● ● | | 1-4 pole |
| 1 pole 2 pole 3 pole | L630 | | | WAA220 WAA221 WAA222 | 4 8 12 | ● | | 1-3 pole |
| 1 pole 2 pole 3 pole | L631 | | | WAA220 WAA221 WAA222 | 4 8 12 | ● | | 1-3 pole |
| 1 pole 2 pole 3 pole | L800 | | | WAA220 WAA221 WAA222 | 4 8 12 | ● | | 1-3 pole |
| 1 pole 2 pole | L1000 | | | WAA220 WAA221 | 6 12 | ● | | 1 and 2 pole |
| 1 pole | L1200 | | | WAA220 | 6 | | | |
| 1 pole | L1600 | | | WAA220 | 8 | | | |
| 1 pole | L2000 | | | WAA220 | 10 | | | |













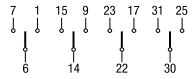

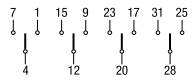

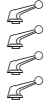
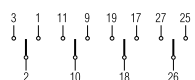

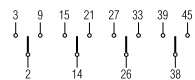

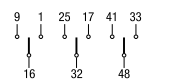

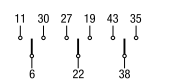



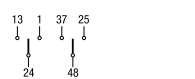

[< back to table of contents >](#)

Switch Function and Configuration

L Switches

| Function/Type | Escutch. Plate | Handle | Code | Stages | Double Latching | Connection Diagram | L350 L630 L1000 L1250 | L351 L631 L1001 L1251 |
|---------------|----------------|--------|------|--------|-----------------|--------------------|--------------------------------|--------------------------------|
|---------------|----------------|--------|------|--------|-----------------|--------------------|--------------------------------|--------------------------------|

Double-throw Switches with Center „OFF" 60° Switching Dimensions p.56

| | | | | | | | | |
|--------------------------------------|-------|---|---|--------------------------------------|-------------------|--------|---|--------------|
| 1 pole 2 pole 3 pole 4 pole | L350 |  |  | WAA210 WAA211 WAA212 WAA213 | 2 4 6 8 | |  | 1-4 pole |
| 1 pole 2 pole 3 pole 4 pole | L351 |  |  | WAA210 WAA211 WAA212 WAA213 | 2 4 6 8 | |  | 1-4 pole |
| 1 pole 2 pole 3 pole 4 pole | L400 |  |  | WAA210 WAA211 WAA212 WAA213 | 2 4 6 8 | |  | 1-4 pole |
| 1 pole 2 pole 3 pole 4 pole | L600 |  |  | WAA210 WAA211 WAA212 WAA213 | 3 6 9 12 | ● ● |  | 1-4 pole |
| 1 pole 2 pole 3 pole | L630 |  |  | WAA210 WAA211 WAA212 | 4 8 12 | ● |  | 1-3 pole |
| 1 pole 2 pole 3 pole | L631 |  |  | WAA210 WAA211 WAA212 | 4 8 12 | ● |  | 1-3 pole |
| 1 pole 2 pole 3 pole | L800 |  |  | WAA210 WAA211 WAA212 | 4 8 12 | ● |  | 1-3 pole |
| 1 pole 2 pole | L1000 |  |  | WAA210 WAA211 | 6 12 | ● |  | 1 and 2 pole |
| 1 pole | L1200 |  |  | WAA210 | 6 | |  | |
| 1 pole | L1600 |  |  | WAA210 | 8 | |  | |
| 1 pole | L2000 |  |  | WAA210 | 10 | |  | |











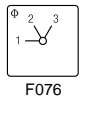

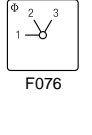

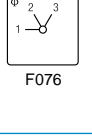

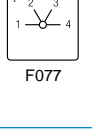
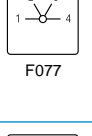

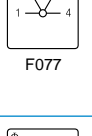

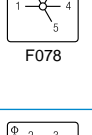

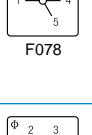
[< back to table of contents >](#)

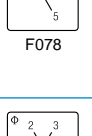
● Additional length for switches size S2 for mounting E/EF = 27 mm
 ● Additional length for switches size S3 for mounting E/EF = 31,5 mm and mounting ER/VE = 20,1 mm

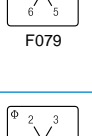
| Function/Type | Escutch. Plate | Handle | Code | Stages | Double Latching | Connection Diagram | L350 L630 L1000 L1250 | L351 L631 L1001 L1251 |
|---------------|----------------|--------|------|--------|-----------------|--------------------|--------------------------------|--------------------------------|
|---------------|----------------|--------|------|--------|-----------------|--------------------|--------------------------------|--------------------------------|

Multi-step Switches single pole without „OFF“

[Dimensions p.56](#)

| | | | | | | | | |
|--------|------|---|---|--------|---|--|--|--|
| 3 Step | L350 |  |  | WAA230 | 4 | |  | |
| 3 Step | L351 |  |  | WAA230 | 4 | |  | |
| 3 Step | L400 |  |  | WAA230 | 4 | |  | |
| 4 Step | L350 |  |  | WAA231 | 4 | |  | |
| 4 Step | L351 |  |  | WAA231 | 4 | |  | |
| 4 Step | L400 |  |  | WAA231 | 4 | |  | |
| 5 Step | L350 |  |  | WAA232 | 6 | |  | |
| 5 Step | L351 |  |  | WAA232 | 6 | |  | |
| 5 Step | L400 |  |  | WAA232 | 6 | |  | |
| 6 Step | L350 |  |  | WAA233 | 6 | |  | |
| 6 Step | L351 |  |  | WAA233 | 6 | |  | |

[< back to table of contents >](#)

| Function/Type | Escutch. Plate | Handle | Code | Stages | Double Latching | Connection Diagram | L350 L630 L1000 L1250 | L351 L631 L1001 L1251 |
|---------------|----------------|--------|------|--------|-----------------|--------------------|--------------------------------|--------------------------------|
|---------------|----------------|--------|------|--------|-----------------|--------------------|--------------------------------|--------------------------------|

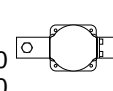

Multi-step Switches single pole without „OFF“

[Dimensions p.56](#)

| | | | | | | | | |
|---------|------|--|--|--------|----|--|--|--|
| 6 Step | L400 | | | WAA233 | 6 | | | |
| 7 Step | L350 | | | WAA234 | 8 | | | |
| 7 Step | L351 | | | WAA234 | 8 | | | |
| 7 Step | L400 | | | WAA234 | 8 | | | |
| 8 Step | L350 | | | WAA235 | 8 | | | |
| 8 Step | L351 | | | WAA235 | 8 | | | |
| 8 Step | L400 | | | WAA235 | 8 | | | |
| 9 Step | L350 | | | WAA236 | 10 | | | |
| 9 Step | L351 | | | WAA236 | 10 | | | |
| 9 Step | L400 | | | WAA236 | 10 | | | |
| 10 Step | L350 | | | WAA237 | 10 | | | |

[< back to table of contents >](#)























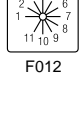

Switch Function and Configuration

L Switches

| Function/Type | Escutch. Plate | Handle | Code | Stages | Double Latching | Connection Diagram | L350 L630 L1000 L1250 | L351 L631 L1001 L1251 |
|---------------|----------------|--------|------|--------|-----------------|--------------------|--------------------------------|--------------------------------|
|---------------|----------------|--------|------|--------|-----------------|--------------------|--------------------------------|--------------------------------|

Multi-step Switches single pole without „OFF“

[Dimensions p. 56](#)

| | | | | | | | |
|---------|------|---|---|--------|----|--|--|
| 10 Step | L351 |  |  | WAA237 | 10 | |  |
| 10 Step | L400 |  |  | WAA237 | 10 | |  |
| 11 Step | L350 |  |  | WAA238 | 12 | |  |
| 11 Step | L351 |  |  | WAA238 | 12 | |  |
| 11 Step | L400 |  |  | WAA238 | 12 | |  |
| 12 Step | L350 |  |  | WAA239 | 12 | |  |
| 12 Step | L351 |  |  | WAA239 | 12 | |  |
| 12 Step | L400 |  |  | WAA239 | 12 | |  |



[< back to table of contents >](#)

| | | | |
|--------------------------------------|-----------------------|-------------|------------------------|
| Two Hole Panel Mount or Mosaic Mount | Terminals rotated 90° | Code | CA4 CA4-1 CAD4-1 |
|--------------------------------------|-----------------------|-------------|------------------------|

[< back to table of contents >](#)

| <p>Panel Mount</p> | | | | |
|---|--|---|------------|--------|
|  | <p>Two hole, Protection IP 40</p> | ● | E E-V | ● ● |
|  | <p>Two hole Protection IP 66/67/69k</p> | ● | EF EF-V | ● ● |
|  | <p>Two hole with shaft for radio knobs, Protection IP 40 Shaft diam. 6 mm/.24 inch</p> | | E9 | ● |
|  | <p>Shaft diam. 6.35 mm/.25 inch, Protection IP 40</p> | | E91 | ● |
| <p>Mosaic Mount</p> | | | | |
|  | <p>For Siemens-Mosaic 30 mm grid depth, Protection IP 40</p> | | E92 | ● |
|  | <p>For Subklew-, Kreutzenbeck-, Symo-Mosaic, Protection IP 40 28 mm 25 mm 25 mm grid depth</p> | | E93 | ● |
|  | <p>For Mauell-Mosaic 30 mm grid depth, Protection IP 40</p> | | E94 | ● |

| | | | | | | |
|------------------------------|-----------------------|------|------------------------|-----------------------|--|-----------------------------------|
| Two or Four Hole Panel Mount | Terminals rotated 90° | Code | CAD.. CA10- CA25 | CA10B- CA63 C42 | C43 C80- C200-4 L350 Size S2 | C315 L400- L2000 Size S2 |
|------------------------------|-----------------------|------|------------------------|-----------------------|--|-----------------------------------|

| | | | | | | |
|--|---|--|---|---|---|---|
| <p>Panel Mount</p>  <p>Four hole, Protection IP 40</p> <p>Four hole, Protection IP 66/67/69k</p> <p>Two hole, Protection IP 66/69k</p> <p>Panel mount using larger face plate, handle and heavy duty stop</p>  <p>Four hole, Protection IP 40</p> <p>Four hole, Protection IP 66/67/69k</p> | <p>●</p> <p>●</p> <p>●</p> <p>●</p> <p>●</p> | <p>E E-V</p> <p>EF EF-V</p> <p>E22 E22-V</p> <p>EG</p> <p>EGF</p> | <p>●</p> <p>●</p> <p>●</p> <p>●</p> <p>●</p> | <p>●</p> <p>●</p> <p>●</p> <p>CA40- CA63</p> <p>CA40- CA63</p> | <p>●</p> <p>●</p> <p>●</p> <p>C80- C200-4</p> <p>C80- C200-4</p> | <p>●</p> <p>●</p> <p>●</p> <p>●</p> <p>●</p> |
| <p>Double End Mount</p>  <p>Four hole, Protection IP 40</p> <p>Four hole, Protection IP 66/67/69k</p> | <p>●</p> <p>●</p> | <p>ER</p> <p>ERF</p> | <p>●</p> <p>●</p> | <p>●</p> <p>●</p> | <p>●</p> <p>●</p> | <p>●</p> <p>●</p> |

< back to table of contents >

| | | | | | |
|-------------------------------------|-------------|------------------------|----------------------------------|------------------------------------|-----|
| Two or Four Hole Panel Mount | Code | CAD.. CA10- CA25 | CA10B CA11B CA20B CA25B | C32 C42 CA40 CA50 CA63 | C43 |
|-------------------------------------|-------------|------------------------|----------------------------------|------------------------------------|-----|

[< back to table of contents >](#)

| | | | | | | |
|---|--|-----------------|------------------------|---|------------------------|--|
|  | <p>Panel mount with heavy duty latching and metal shaft</p> <p>Four hole, Protection IP 40 48 x 48 Plate – S0</p> | KN2 | ● | | | |
|  | <p>Four hole, Protection IP 40 64 x 64 Plate – S1</p> | KN1 | ● | ● | ● | |
|  | <p>Four hole, Protection IP 40 64 x 64 Plate – S1 complete with 6mm square metal shaft</p> | KD1 | ● | ● | ● | |
| Panel mount with protective cover | | | | | | |
|  | <p>Four hole Protection front IP 40 rear IP 40</p> | EC | CAD.. CA10- CA25 | ● | | |
|  | <p>Four hole with additional shaft seal Protection front IP 66/67/69k rear IP 40</p> | ED | CAD.. CA10- CA25 | ● | | |
|  | <p>Four hole Protection front IP 40 rear IP 42</p> | EC1 | | ● | | |
|  | <p>Four hole with additional shaft seal Protection front IP 66/67/69k rear IP 42</p> <p>Two hole Protection front IP 66/69k rear IP 42</p> | ED1 ED22 | | ● | CAD.. CA10- CA25 | |

| | | | | |
|-------------------|-----------------------|------|------------------------|------------------------|
| Single Hole Mount | Terminals rotated 90° | Code | CA4 CA4-1 CAD4-1 | CAD.. CA10- CA25 |
|-------------------|-----------------------|------|------------------------|------------------------|

| | | Code | mm | mm |
|--|---|--------------|----------------|----------------|
|  <p>Single Hole Mount complete with lock nut and shaft seal Bezel mount, Protection IP 66/67/69k</p> | ● | FS1 FS1-V | 16/22 16/22 | 22 |
| | ● | FT1 FT1-V | | 22 |
|  <p>Square face plate, Protection IP 66/67/69k</p> | ● | FS2 FS2-V | 16/22 16/22 | 22 |
| | ● | FT2 FT2-V | | 22 |
| | ● | FT3 FT3-V | | 22/30 22/30 |
| <p>S1 square face plate and heavy duty stop, Protection IP 66/67/69k</p> | ● | FH3 FH3-V | | 22 22 |
|  <p>Rectangular face plate, Protection IP 66/67/69k</p> | ● | FS4 FS4-V | 16/22 16/22 | 22 |
| | ● | FT6 FT6-V | | 22 |
|  <p>Lock nut spanner</p> | | S00 T170 09 | | |

[< back to table of contents >](#)

| Base Mount | Terminals rotated 90° | Code | CAD.. CA10- CA25 | CA10B- CA63 C42 | C43 C80- L2000 |
|------------|-----------------------|------|------------------|-----------------|----------------|
|------------|-----------------------|------|------------------|-----------------|----------------|

Base Mount



Four hole, Protection IP 40

Four hole with integrated simplified door clutch, Protection IP 65



Two hole, Protection IP 40

Two hole with integrated simplified door clutch, Protection IP 65



Snap-on for DIN Rail EN 60715, Protection IP 40

| | | | | |
|---|---------------|------------------|---|---|
| ● | VE VE-V | CAD.. CA10- CA25 | ● | ● |
| ● | VF VF-V | CAD.. CA10- CA25 | ● | |
| ● | VE22 VE22V | CAD.. CA10- CA25 | ● | |
| ● | VF22 VF22V | CAD.. CA10- CA25 | ● | |
| | VE1 | | ● | ● |

| | | | |
|-------------------|-------------|------------------------|------------------------|
| Base Mount | Code | CA4 CA4-1 CAD4-1 | CAD.. CA10- CA25 |
|-------------------|-------------|------------------------|------------------------|

DIN Rail Mount



Snap-on for DIN Rail EN 60715 with face plate for 45 mm standard knock-out.

VE2



Snap-on for DIN Rail EN 60715. With face plate for 45 mm standard knock-out. The handle and plate are adjustable in height.

VE21





CAD..
CA10-
CA20

VE21V

CA25

[< back to table of contents >](#)

| | | |
|---|--------------------|---------------------------------|
| <p>Mounting Plates for Plaster Depth Boxes acc. to DIN 49073 and ÖNORM E8608</p> | <p>Code</p> | <p>CAD.. CA10- CA25</p> |
|---|--------------------|---------------------------------|

| | | | |
|--|---|------------|----------|
|  | <p>Plaster depth trim, Protection IP 40</p> | <p>UE1</p> | <p>●</p> |
|  | <p>With light, Protection IP 40</p> | <p>UE2</p> | <p>●</p> |
| | <p>With facility for light addition, Protection IP 40</p> | <p>UE3</p> | <p>●</p> |

< back to table of contents >

Face plates



Square and rectangular face plates are available for each size of switch. The face plate consists of a frame and a faceplate having the switch positions which is then embossed with hot-foil backing. The face plate frame is an essential part of the switch and serves as a bearing surface for the handle. If the switch is to be mounted without an face plate we would recommend for size S1, S2 and S3 the handle bearing plate T100-04.

Standard Letterings Available

(Over 500 standard letterings, special letterings upon request.)

30° switching

| | | | | | | | | | | | | | | | | | |
|------|------|------|------|------|------|------|------|------|------|------|------|------|------|------|------|------|------|
| F022 | F141 | F158 | F703 | F023 | F137 | F142 | F159 | F701 | F704 | F152 | F709 | F026 | F035 | F153 | F169 | F024 | F143 |
| F160 | F221 | F222 | F224 | F025 | F034 | F036 | F037 | F038 | F039 | F139 | F144 | F147 | F149 | F150 | F151 | F219 | F258 |
| F259 | F273 | F280 | F329 | F384 | F708 | F053 | F161 | F297 | F298 | F306 | F307 | F001 | F040 | F052 | F229 | F355 | F018 |
| F019 | F029 | F030 | F154 | F155 | F165 | F166 | F183 | F184 | F301 | F302 | F321 | F332 | F333 | F334 | F335 | F374 | F711 |
| F712 | F002 | F021 | F033 | F041 | F055 | F305 | F319 | F054 | F003 | F042 | F138 | F255 | F299 | F308 | F353 | F350 | F351 |
| F004 | F014 | F017 | F020 | F027 | F028 | F031 | F032 | F043 | F049 | F135 | F156 | F157 | F162 | F167 | F168 | F187 | F189 |
| F303 | F304 | F336 | F337 | F347 | F348 | F710 | F713 | F714 | F734 | F005 | F044 | F136 | F140 | F702 | F006 | F010 | F045 |
| F015 | F050 | F007 | F011 | F046 | F008 | F012 | F047 | F016 | F051 | F009 | F013 | F048 | F748 | | | | |

45° switching

| | | | | | | | | | | | | | | | | | |
|------|------|------|------|------|------|------|------|------|------|------|------|------|------|------|------|------|------|
| F747 | F295 | F742 | F743 | F215 | F216 | F738 | F744 | F746 | F792 | F793 | F107 | F109 | F114 | F115 | F212 | F213 | F214 |
| F217 | F267 | F289 | F330 | F375 | F376 | F383 | F408 | F409 | F410 | F411 | F412 | F413 | F426 | F427 | F430 | F729 | F752 |
| F775 | F776 | F777 | F778 | F779 | F780 | F781 | F796 | F797 | F798 | F105 | F108 | F112 | F113 | F117 | F118 | F293 | F429 |
| F739 | F741 | F419 | F789 | F790 | F791 | F794 | F795 | F110 | F106 | F116 | F294 | F317 | F414 | F415 | F416 | F417 | F418 |
| F782 | F783 | F784 | F785 | F786 | F787 | F788 | F799 | F111 | F210 | F211 | F284 | F285 | F296 | F322 | F727 | F740 | |

← back to table of contents →

Face plates

60° switching

| | | | | | | | | | | | | | | | | | |
|------|------|------|------|------|------|------|------|------|------|------|------|------|------|------|------|------|------|
| F707 | F087 | F088 | F089 | F133 | F197 | F198 | F232 | F243 | F247 | F263 | F268 | F310 | F311 | F323 | F328 | F352 | F367 |
| F379 | F380 | F470 | F754 | F072 | F163 | F164 | F192 | F193 | F196 | F230 | F231 | F234 | F244 | F257 | F262 | F264 | F282 |
| F288 | F291 | F313 | F382 | F441 | F705 | F721 | F722 | F750 | F757 | F758 | F075 | F076 | F098 | F220 | F223 | F356 | F357 |
| F377 | F723 | F071 | F073 | F080 | F081 | F085 | F086 | F090 | F091 | F092 | F093 | F094 | F104 | F194 | F235 | F237 | F239 |
| F240 | F241 | F249 | F260 | F269 | F274 | F281 | F290 | F292 | F312 | F314 | F315 | F316 | F324 | F331 | F344 | F354 | F358 |
| F359 | F364 | F370 | F371 | F373 | F381 | F385 | F442 | F444 | F469 | F732 | F735 | F759 | F077 | F100 | F101 | F102 | F309 |
| F342 | F343 | F361 | F362 | F363 | F365 | F366 | F078 | F191 | F325 | F326 | F720 | F074 | F082 | F096 | F097 | F195 | F724 |
| F256 | F079 | F083 | F084 | F095 | F099 | F185 | F190 | F199 | F233 | F236 | F238 | F242 | F283 | F725 | F730 | F731 | F736 |
| F737 | | | | | | | | | | | | | | | | | |

[< back to table of contents >](#)

90° switching

| | | | | | | | | | | | | | | | | | |
|------|------|------|------|------|------|------|------|------|------|------|------|------|------|------|------|------|------|
| F056 | F063 | F068 | F134 | F201 | F251 | F252 | F346 | F456 | F058 | F065 | F069 | F177 | F178 | F182 | F208 | F253 | F254 |
| F340 | F360 | F378 | F458 | F443 | F700 | F743 | F057 | F061 | F064 | F067 | F171 | F181 | F205 | F207 | F180 | F320 | F349 |
| F437 | F445 | F715 | F719 | F059 | F060 | F062 | F066 | F170 | F172 | F173 | F174 | F175 | F176 | F179 | F180 | F186 | F188 |
| F202 | F204 | F206 | F250 | F265 | F266 | F286 | F318 | F327 | F338 | F339 | F425 | F716 | F717 | F718 | F726 | F733 | F751 |
| F756 | | | | | | | | | | | | | | | | | |

Miscellaneous





| | | | | | | | | | | | | | | | | | |
|------|------|------|------|------|------|------|------|------|------|------|------|------|------|------|------|------|------|
| F119 | F130 | F122 | F126 | F125 | F129 | F225 | F248 | F246 | F261 | F341 | F345 | F287 | F123 | F127 | F145 | F146 | F148 |
| F706 | F707 | F245 | F120 | F124 | F128 | F131 | F121 | F132 | F749 | | | F990 | F991 | F801 | F802 | F803 | F804 |
| F805 | F806 | F807 | F808 | F809 | F810 | F811 | F812 | F813 | F814 | F815 | F816 | F817 | F818 | F819 | F820 | F821 | F822 |
| F823 | F824 | F825 | F826 | F827 | F828 | F829 | F830 | F831 | F832 | F833 | F834 | F835 | F837 | F838 | F839 | F840 | F841 |

¹INTERRUPTEUR PRINCIPAL, OUVERTURE EN POSITION 0 ²INTERRUPTORE GENERALE, APRIRE SOLO CON MANIGLIA SU 0
³INTERRUPTOR PRINCIPAL, ABRIR ARMARIO SOLO EN POS. "0"

Handles

| Type | Color | Code | Size S00 S0 S1 S2 S3 |
|------|-------|------|-------------------------|
|------|-------|------|-------------------------|

















| Type | Color | Code | Size S00 S0 S1 S2 S3 |
|------|-------|------|-------------------------|
|------|-------|------|-------------------------|

| | | | |
|---|--------------|--------------|------------------------|
| <p>R-Handle</p>  | black red | G001 G002 | — ● ● ● ● — ● ● ● ● |
| <p>F-Handle</p>  | black red | G221 G222 | ● ● ● ● — ● ● ● ● — |
| <p>S-Handle</p>  <p>S0 S1</p> | black red | G301 G302 | — ● ● — — — ● ● — — |
| <p>P-Handle</p>  <p>S0 S1-S3</p> | black red | G211 G212 | — ● ● ● ● — ● ● ● ● |
| <p>Handwheel</p>  | black | G971 | — — — — ● |

| | | | |
|---|--------------|--------------|------------------------|
| <p>I-Handle</p>  <p>S00 S0-S3</p> | black red | G251 G252 | ● ● ● ● ● ● ● ● ● ● |
| <p>B-Handle</p>  | black red | G521 G522 | — ● ● — — — ● ● — — |
| <p>L-Handle</p>  | black red | G501 G502 | — — ● — — — — ● — — |
| <p>K-Handle</p>  | black red | G411 G412 | — — ● ● ● — — ● ● ● |
| <p>O-Handle</p>  | black red | G321 G322 | — — ● — — — — ● — — |

[< back to table of contents >](#)

International Standards and Approvals

| Country | Authority | Mark or Standard | CAD11/12 | CA10 | CA10B | | C26 | CA40 | C43 | L350/1 | | L400 | L1200 | |
|--|--|--|----------|------|-------|-------|-----|------|------|--------|------|------|-------|---|
| | | | CA4 | CA11 | CA11B | CA25 | C32 | CA50 | C80 | L630/1 | C315 | L600 | L1600 | |
| | | | CA4-1 | CA20 | CA20B | CA25B | C42 | CA63 | C125 | L1000 | C316 | L800 | L2000 | |
| USA | Underwriters Laboratories Inc. |  ¹ | | | | | | | | ● | ● | ● | ● | |
| | |  ² ³ | ● | ● | ● | ● | ● | ● | ● | ● | | | ● | |
| Canada | UL investigated acc. to CSA |  ⁶ | ● | ● | ● | ● | ● | ● | ● | ● | ● | ● | ● | |
| | |  ¹ _c | | | | | | | | | ● | ● | ● | ● |
| | |  ² ³ _c | ● | ● | ● | ● | ● | ● | ● | ● | | | ● | |
| Switzerland | Schweizerischer Elektrotechnischer Verein |  | + | + | + | | + | + | + | + | + | + | + | |
| Denmark | Danmarks Elektriske Materielkontrol |  | + | + | + | | + | + | + | + | + | + | + | |
| Norway | Norges Elektriske Materielkontrol |  | + | + | + | | + | + | + | + | + | + | + | |
| Sweden | Svenska Elektriska Materielkontrollanstalten |  | + | + | + | | + | + | + | + | + | + | + | |
| Finland | Sähkötar-kastuskeskus |  | + | + | + | | + | + | + | + | + | + | + | |
| Austria | Österreichischer Verband für Elektrotechnik |  | + | + | + | | + | + | + | + | + | + | + | |
| Federal Republic of Germany | Verband Deutscher Elektrotechniker | VDE 0660 ⁴ | + | + | + | | + | + | + | + | + | + | + | |
| Great Britain | British Standards Institution | BS EN 60947 ⁴ | + | + | + | | + | + | + | + | + | + | + | |
| International Electrical Commission (IEC) Recommendation | | IEC 60947 ⁵ | + | + | + | | + | + | + | + | + | + | + | |
| China | China Quality Certification Centre |  GB14048.3 | ● | ● | ● | | | | | | | | | |
| Russia Belarus Kazakhstan | Eurasian Conformity |  | ● | ● | ● | ● | ● | ● | ● | + | + | + | + | |
| Russian Federation | Russian Maritime Register of Shipping |  | ● | ● | ● | ● | | | | | | | | |
| Germanischer Lloyd | |  | + | + | + | | + | + | + | + | + | + | + | |
| Lloyds Register EMEA | |  | + | + | + | | + | + | + | + | + | + | + | |

● Switch approved

+ Switch conforms to requirements

+ No approval required

¹ Approved under the "Component Program" (UL-Recognized Industrial Component). File No. E35541, Category Control No. NLRV2 (U.S.) and NLRV8 (Canada) resp. File No. E60262, Category Control Number NRNT2 (U.S.) and NRNT8 (Canada).

² Approved under the "Listing Program". File No. E35541, Category Control No. NLRV (U.S.) resp. NLRV7 (Canada).

³ Switch types CAD11/CAD12 approved under the "Listing Program". File No. E60262, Category Control No. NRNT (U.S.) resp. NRNT7 (Canada).

⁴ It is not required for Industrial Switchgear to bear a symbol but must conform to requirements. By stating the specific standard no. on the product the manufacturer declares that all requirements of the product standard are met.

⁵ IEC does not operate an approval scheme.

⁶ File No. 13002ass No. 3211-05 resp. 4652-04.

| | |
|-----------------------|---|
| Selection Data | CA4 CA10 CA11 CA20 CA25 C42 C315 |
| | CA4-1 CA10B CA11B CA20B CA25B C26 C32 C43 CA40 CA50 CA63 C80 C125 C200-4 C316 |

| | | | | | | | | | | | | | | | | | | |
|--|---|--|--|------|------|-------|------|-------|-----------------|-------|------|------|------|-------|------|------|------|------------|
| Rated Insulation Voltage U_i | IEC 60947-3, EN 60947-3 ¹ VDE 0660 part 107 ¹ | V | 440 | 690 | 690 | 690 | 690 | 690 | 690 | 690 | 690 | 690 | 690 | 690 | 690 | 690 | 690 | 1000 |
| | SEV ⁴ | V | 380 | 660 | 660 | 660 | 690 | 660 | 660 | 660 | 690 | 690 | 690 | 660 | 660 | - | 660 | |
| | UL/Canada | V | 300 | 300 | 600 | 600 | 300 | 600 | 600 | 600 | 600 | 600 | 600 | 600 | 600 | - | 600 | |
| | CEE/NEMKO | V | 400/380 | 380 | 400 | 400 | - | 400 | 400 | 400 | - | - | - | 400 | - | - | - | |
| | min. voltage | | | | | | | | | | | | | | | | | on request |
| Rated Impulse Withstand Voltage U_{imp} | | kV | 4 | 6 | 6 | 6 | 6 | 6 | 6 | 6 | 6 | 6 | 6 | 6 | 6 | 6 | 6 | 6/8 |
| Rated Thermal Current I_u/I_{th} | IEC 60947-3, EN 60947-3 VDE 0660 part 107 | A | 10 | 20 | 20 | 25 | 32 | 32 | 50 | 63 | 40 | 50 | 63 | 115 | 150 | 200 | 315 | |
| | SEV ³ 380 V | A | 10 | 16 | 16 | 25 | 32 | 32 | 40 | 63 | 40 | 50 | 63 | 100 | 160 | - | 315 | |
| | 660 V | A | - | 12 | 12 | 25 | 32 | 32 | 40 | 63 | 40 | 50 | 63 | - | - | - | 315 | |
| | UL/Canada | A | 10 | 20 | 20 | 30 | 30 | 40 | 50 | 65 | 45 | 55 | 65 | 100 | 150 | - | 240 | |
| Rated Operational Current I_e | AC-21A Switching of resistive loads, including moderate overloads | IEC 60947-3, EN 60947-3 VDE 0660 part 107 | A | 10 | 20 | 20 | 25 | 32 | 32 | 40 | 63 | 40 | 50 | 63 | 100 | 150 | 200 | 315 |
| | AC-1 Resistive or low inductive loads | SEV ⁴ 380 V 660 V | A | 10 | 16 | 16 | 25 | 32 | 32 | 40 | 63 | 40 | 50 | 63 | 100 | 160 | - | 315 |
| | | | A | - | 12 | 12 | 20 | 32 | 32 | 40 | 63 | 40 | 50 | 63 | - | - | - | 315 |
| AC-22A Switching of combined resistive or low inductive loads including moderate overloads | IEC 60947-3, EN 60947-3 VDE 0660 220 V-500 V part 107 660 V-690 V | A | 10 | 20 | 20 | 25 | 32 | 32 | 40 | 63 | 40 | 50 | 63 | 100 | 150 | 150 | 315 | |
| | | A | - | 20 | 20 | 25 | 32 | 32 | 40 | 63 | 40 | 50 | 63 | 100 | 125 | 125 | 125 | |
| AC-15 Switching of control devices, contactors, valves etc. | IEC 60947-5-1, EN 60947-5-1 VDE 0660 220 V-240 V part 200 380 V-440 V | A | 2,5 | 5 | 5 | 8 | 12 | 14 | 16 | - | 14 | 16 | 16 | - | - | - | - | |
| | | A | 1,5 | 4 | 4 | 5 | 6 | 6 | 7 | - | 6 | 7 | 7 | - | - | - | - | |
| Pilot Duty | UL/Canada ³ Heavy | VAC | A300 | A300 | A600 | A600 | A300 | A600 | A600 | A600 | A600 | A600 | A600 | - | - | - | A600 | |
| Ampere Rating Resistive or low inductive loads | UL/Canada ³ | A | 10 | 20 | 20 | 30 | 30 | 40 | 50 | 65 | 45 | 55 | 60 | 100 | 150 | - | 240 | |
| Resistive load/motor load | CEE | A | 4/2 | 10/6 | 10/6 | 16/10 | - | 25/10 | 32/10 | 40/10 | - | - | - | 63/10 | - | - | - | |
| | NEMKO | A | 6/4 ² | 10/6 | - | 20/10 | - | - | - | - | - | - | - | - | - | - | - | |
| Breaking capacity | 220 V-240 V | A | 50 | 150 | 150 | 200 | 280 | 280 | 380 | 550 | 290 | 330 | 440 | 860 | 1100 | 1100 | 2000 | |
| | 380 V-440 V | A | 50 | 150 | 150 | 200 | 250 | 250 | 360 | 550 | 290 | 330 | 440 | 860 | 1100 | 1100 | 2000 | |
| | 660 V-690 V | A | - | 80 | 80 | 125 | 150 | 150 | 270 | 365 | 170 | 200 | 260 | 400 | 490 | 490 | 340 | |
| Power loss per contact at I_u | | W | 0,4/0,9 | 0,9 | 0,9 | 0,9 | 0,7 | 1,3 | 1,3 | 1,7 | 1 | 1,8 | 2,8 | 5,8 | 3,8 | 6,7 | 17 | |
| Resistance to vibration | | | min. 4 g, 2-100 Hz, 1,6 mm | | | | | | on request | | | | | | | | | |
| Resistance to shock | | | min. 5 g, 6 ms | | | | | | min. 5 g, 30 ms | | | | | | | | | |
| Short Circuit Protection | Max. fuse size (gG-characteristic) | A | 10 | 25 | 25 | 35 | 35 | 50 | 63 | 80 | 50 | 63 | 63 | 125 | 200 | 200 | 315 | |
| | Rated short-time withstand current (1s-current) | A | 60 | 140 | 140 | 280 | 480 | 350 | 800 | 1000 | 950 | 950 | 950 | 1300 | 2000 | 2000 | 4200 | |
| Min. Ambient Temperature of Stages | | | -25 °C (valid only without optional extra, C315/C316 on request) | | | | | | | | | | | | | | | |
| Max. Ambient Temperature of Stages ^{5,7} open at 100 % I_u/I_{th} enclosed at 100 % I_{the} | | | 55 °C during 24 hours with peaks up to 60 °C | | | | | | | | | | | | | | | |
| | | | 35 °C during 24 hours with peaks up to 40 °C | | | | | | | | | | | | | | | |

[< back to table of contents >](#)

44 ¹Valid for lines with grounded common neutral termination, overvoltage category III, pollution degree 3. Values for other supply systems on request. ²Valid for CA4 only. ³International Standards and Approvals, refer to page 43. ⁴For electromagnetic optional extras see additional data in Catalog 101. ⁵Storage temperature: -40 °C to 85 °C (in case of temperature below -5 °C no shock load permissible).

| | | |
|-----------------------|---|------|
| Selection Data | CA4 CA10 CA11 CA20 CA25 C42 | C315 |
| | CA4-1 CA10B CA11B CA20B CA25B C26 C32 C43 CA40 CA50 CA63 C80 C125 C200-4 C316 | |

[< back to table of contents >](#)

| Rated Utilization Category | | IEC 60947-3, EN 60947-3 VDE 0660 part 107 | | | | | | | | | | | | | | | | | | |
|----------------------------|---|--|----------------------|----|------|------|------|------|------|------|------|------|------|------|------|------|-----|-----|------|-----|
| AC-2 | Slip ring motor starting, reversing and plugging, star-delta starting CA4-CA50 | 3 phase | 220 V-240 V | kW | 2,5 | 4 | 4 | 5,5 | 7,5 | 8 | 10 | 18,5 | 10 | 11 | 18,5 | 30 | 37 | 37 | 55 | |
| | | 3 pole | 380 V-440 V | | 4,5 | 7,5 | 7,5 | 11 | 15 | 15 | 18,5 | 30 | 18,5 | 22 | 30 | 40 | 55 | 75 | 75 | 110 |
| | | | 500 V 660 V-690 V | | - | 10 | 10 | 10 | 13 | 15 | 15 | 22 | 37 | 22 | 30 | 37 | 55 | 55 | 55 | 55 |
| AC-3 | Direct-on-line starting, star-delta starting CA63-C315 | 3 phase | 220 V-240 V | kW | 1,5 | 3 | 3 | 4 | 5,5 | 5,5 | 7,5 | 11 | 7,5 | 11 | 11 | 15 | 22 | 22 | 37 | |
| | | 3 pole | 380 V-440 V | | 2,2 | 5,5 | 5,5 | 7,5 | 11 | 11 | 15 | 18,5 | 15 | 18,5 | 18,5 | 30 | 37 | 37 | 55 | |
| | | | 500 V 660 V-690 V | | - | 5,5 | 5,5 | 7,5 | 11 | 11 | 15 | 18,5 | 15 | 18,5 | 18,5 | 30 | 37 | 37 | 55 | |
| | | | | | - | 5,5 | 5,5 | 7,5 | 11 | 11 | 15 | 18,5 | 15 | 18,5 | 22 | 30 | 30 | 30 | 37 | |
| | | 1 phase | 110 V-120 V | kW | 0,3 | 0,6 | 0,6 | 1,5 | 2,2 | 2,2 | 2,5 | 3 | 2,5 | 3 | 3 | 3,7 | 5,5 | 5,5 | 11 | |
| | 2 pole | 220 V-240 V | 0,55 | | 2,2 | 2,2 | 3 | 4 | 4 | 5,5 | 6 | 5,5 | 6 | 6 | 7,5 | 11 | 11 | 22 | | |
| | 380 V-440 V | 0,75 | 3 | | 3 | 3,7 | 5,5 | 5,5 | 7,5 | 11 | 7,5 | 11 | 11 | 13 | 18,5 | 18,5 | 30 | | | |
| AC-4 | Direct-on-line starting, reversing, plugging and inching | 3 phase | 220 V-240 V | kW | 0,37 | 0,55 | 0,55 | 1,5 | 2,5 | 2,7 | 3,7 | 5,5 | 3,7 | 4 | 5,5 | 6 | 10 | 10 | 15 | |
| | | 3 pole | 380 V-440 V | | 0,55 | 1,5 | 1,5 | 3 | 5,5 | 5,5 | 6 | 7,5 | 6 | 7 | 7,5 | 11 | 15 | 15 | 25 | |
| | | | 500 V 660 V-690 V | | - | 1,5 | 1,5 | 3 | 5,5 | 5,5 | 6 | 7,5 | 6 | 7 | 7,5 | 11 | 15 | 15 | 25 | |
| | | | | | - | 1,5 | 1,5 | 3 | 5,5 | 5,5 | 6 | 7,5 | 6 | 7,5 | 9 | 11 | 15 | 15 | 22 | |
| | | 1 phase | 110 V-120 V | kW | 0,15 | 0,3 | 0,3 | 0,45 | 0,75 | 0,75 | 1,1 | 1,2 | 1,1 | 1,2 | 1,2 | 1,5 | 2,2 | 2,2 | 4 | |
| | 2 pole | 220 V-240 V | 0,25 | | 0,75 | 0,75 | 1,1 | 1,5 | 1,5 | 2,2 | 2,4 | 2,2 | 2,4 | 2,4 | 3 | 4 | 4 | 7,5 | | |
| | 380 V-440 V | 0,5 | 1,5 | | 1,5 | 2,2 | 3 | 3 | 3,7 | 4 | 3,7 | 4 | 4 | 4 | 5,5 | 7,5 | 7,5 | 11 | | |
| AC-23A | Frequent switching of motors or other high inductive loads | 3 phase | 220 V-240 V | kW | 1,8 | 3,7 | 3,7 | 5,5 | 7,5 | 7,5 | 11 | 15 | 7,5 | 11 | 15 | 30 | 37 | 37 | 75 | |
| | | 3 pole | 380 V-440 V | | 3 | 7,5 | 7,5 | 11 | 15 | 15 | 22 | 30 | 18,5 | 22 | 30 | 45 | 75 | 75 | 132 | |
| | | | 500 V 660 V-690 V | | - | 7,5 | 7,5 | 11 | 15 | 15 | 30 | 45 | 18,5 | 22 | 30 | 55 | 90 | 90 | 132 | |
| | | | | | - | 7,5 | 7,5 | 11 | 15 | 15 | 22 | 40 | 18,5 | 22 | 30 | 45 | 55 | 55 | 37 | |
| | | 1 phase | 110 V-120 V | kW | 0,37 | 0,75 | 0,75 | 1,5 | 2,2 | 2,2 | 2,5 | 4 | 2,2 | 2,5 | 4 | 5,5 | 11 | 11 | 18,5 | |
| | 2 pole | 220 V-240 V | 0,75 | | 2,5 | 2,5 | 3 | 4 | 4 | 5,5 | 10 | 4 | 5,5 | 10 | 15 | 22 | 22 | 37 | | |
| | 380 V-440 V | 1,1 | 3,7 | | 3,7 | 5,5 | 7,5 | 7,5 | 11 | 18,5 | 7,5 | 11 | 18,5 | 22 | 37 | 37 | 55 | | | |
| Ratings | | UL/Canada | | | | | | | | | | | | | | | | | | |
| | Standard motor load DOL-Rating (similar AC-3) | 3 phase | 110 V-120 V | HP | 0,75 | 1,5 | 1,5 | 3 | 5 | 5 | 7,5 | 7,5 | 7,5 | 7,5 | 7,5 | 10 | 15 | - | 30 | |
| | | 3 pole | 220 V-240 V | | 1 | 3 | 3 | 7,5 | 10 | 10 | 15 | 15 | 15 | 15 | 20 | 25 | - | 75 | | |
| | | | 440 V-480 V | | - | - | 5 | 10 | - | 20 | 25 | 25 | 25 | 25 | 30 | 40 | - | 75 | | |
| | | | 550 V-600 V | | - | - | 5 | 10 | - | 25 | 30 | 30 | 25 | 30 | 30 | 40 | 50 | - | 60 | |
| | | 1 phase | 110 V-120 V | HP | 0,33 | 0,5 | 0,5 | 1,5 | 2 | 2 | 3 | 3 | 3 | 3 | 5 | 7,5 | - | 15 | | |
| | 2 pole | 220 V-240 V | 0,75 | | 1 | 1 | 3 | 5 | 5 | 7,5 | 7,5 | 7,5 | 7,5 | 10 | 15 | - | 40 | | | |
| | 277 V | 0,75 | 2 | | 2 | 3 | 5 | 5 | 7,5 | 7,5 | 7,5 | 7,5 | 10 | 10 | 15 | - | 40 | | | |
| | 440 V-480 V 550 V-600 V | - | - | | 2 | 5 | - | 10 | 15 | 15 | 15 | 15 | 15 | 20 | 25 | - | 50 | | | |
| | | | | | - | - | 2 | 5 | - | 15 | 20 | 20 | 15 | 20 | 20 | 25 | 30 | - | 50 | |
| | Heavy motor load Reversing-Rating (similar AC-4) | 3 phase | 110 V-120 V | HP | - | 0,5 | 0,5 | 1 | 2 | 2 | 3 | 5 | - | - | - | 7,5 | 10 | - | 15 | |
| | | 3 pole | 220 V-240 V | | - | 1 | 1 | 2 | 3 | 3 | 5 | 7,5 | - | - | - | 15 | 20 | - | 30 | |
| | | | 440 V-600 V | | - | - | 3 | 5 | - | 10 | 15 | 20 | - | - | - | 25 | 30 | - | 40 | |
| | | | | | | | | | | | | | | | | | | | | |
| | | 1 phase | 110 V-120 V | HP | - | 0,17 | 0,17 | 0,33 | 1,5 | 1,5 | 1,5 | 2 | - | - | - | 3 | 5 | - | 7,5 | |
| | 2 pole | 220 V-240 V | - | | 0,5 | 0,5 | 0,75 | 3 | 3 | 3 | 5 | - | - | - | 7,5 | 10 | - | 15 | | |
| | 277 V | - | 0,6 | | 0,6 | 1 | 3 | 3 | 3 | 5 | - | - | - | 7,5 | 10 | - | 15 | | | |

| | |
|-----------------------|---|
| Selection Data | CA4 CA10 CA11 CA20 CA25 C42 C315 |
| | CA4-1 CA10B CA11B CA20B CA25B C26 C32 C43 CA40 CA50 CA63 C80 C125 C200-4 C316 |

| | | | | | | | | | | | | | | | | | | |
|---|-----------------|------------------------------|----------|----------|----------|--------|--------|-------|-------|--------|--------|--------|--------|----------------------------------|------|-------|-------|-------|
| Max. Permissible Wire Gage - Use copper wire only | | | | | | | | | | | | | | | | | | |
| Single-core or stranded wire | mm ² | 2x 1,5 | 2x 2,5 | 2x 2,5 | 2x 4 | 2x 6 | 2x 6 | 2x 10 | 2x 16 | 16 16 | 16 16 | 16 16 | 35 70 | 95 ¹ 185 ¹ | | | | |
| | AWG | 14 | 12 | 12 | 10 | 8 | 8 | 8 | 6 | 6 | 6 | 6 | 2 | 2/0 - MCM 350 | | | | |
| Flexible wire (sleeving in accordance with DIN 46228) Flexible AWG wires (without sleeve) | mm ² | 2x 1,5 | 2x 2,5 | 2x 2,5 | 2x 4 | 2x 4 | 2x 6 | 2x 6 | 2x 10 | 10 10 | 10 10 | 10 10 | 25 50 | 95 ¹ 150 ¹ | | | | |
| | AWG | (1) 16 | (2,5) 14 | (2,5) 14 | (2,5) 12 | (4) 10 | (4) 10 | (6) 8 | (6) 6 | (10) 6 | (10) 6 | (10) 6 | (25) 3 | (50) 1/0 - MCM 300 | | | | |
| Tightening torque of screws | | | | | | | | | | | | | | | | | | |
| | Nm | 0,4 | 0,6 | 0,6 | 1,3 | 1,3 | 1,3 | 2,2 | 3 | 1,8 | 1,8 | 1,8 | 4 | 4,5 8 14 | | | | |
| | lb-in | 3,5 | 5 | 5 | 12 | 12 | 12 | 19,5 | 26,4 | 16 | 16 | 16 | 35 | 39,8 70 125 | | | | |
| DC Switching Capacity² | | | | | | | | | | | | | | | | | | |
| contacts in series:: | | 1 | 2 | 3 | 4 | 5 | 6 | 8 | | | | | | | | | | |
| | | Permissible voltage in volts | | | | | | | | | | | | | | | | |
| Utilization category DC-21A | | 24 | 48 | 72 | 96 | 120 | 144 | 192 | A | CA4 | CA10 | CA10S | CA20 | CA20S | CA25 | CA25S | CA40S | CA63S |
| Switching of resistive load | | 48 | 96 | 144 | 192 | 240 | 288 | 384 | A | - | 16 | 16 | 21 | 24 | 26 | 32 | 40 | 63 |
| Time constant L/R≤1ms | | 60 | 120 | 180 | 240 | 300 | 360 | 480 | A | - | 14 | 15 | 18 | 24 | 25 | 32 | 40 | 63 |
| | | 110 | 220 | 330 | 440 | 550 | 660 | - | A | - | 13 | 15 | 17 | 21 | 24 | 28 | 40 | 50 |
| | | 220 | 440 | 660 | - | - | - | - | A | - | 6 | 7 | 6 | 7 | 7 | 9,3 | - | - |
| | | | | | | | | | A | - | 0,9 | 1 | 1 | 1 | 1 | - | - | |
| Utilization category DC-22A | | 24 | 48 | 72 | 96 | 120 | 144 | 192 | A | CA4 | CA10 | CA10S | CA20 | CA20S | CA25 | CA25S | CA40S | CA63S |
| Switching of mixed resistive and inductive load | | 48 | 96 | 144 | 192 | 240 | 288 | 384 | A | - | 14 | 15 | 18 | 24 | 25 | 32 | 40 | 63 |
| f.e. shunt motors | | 60 | 120 | 180 | 240 | 300 | 360 | 480 | A | - | 13 | 15 | 17 | 24 | 25 | 32 | 40 | 63 |
| time constant L/R≤2,5ms | | 110 | 220 | 330 | 440 | 550 | 660 | - | A | - | 12 | 15 | 16 | 19 | 24 | 25 | 20 | 25 |
| | | 220 | 440 | 660 | - | - | - | - | A | - | 1,9 | 2 | 2 | 2 | 2,25 | 3 | - | - |
| | | | | | | | | | A | - | 0,3 | 0,35 | 0,3 | 0,35 | 0,35 | 0,35 | - | - |
| Utilization category DC-23A | | 24 | 48 | 72 | 96 | 120 | 144 | 192 | A | CA4 | CA10 | CA10S | CA20 | CA20S | CA25 | CA25S | CA40S | CA63S |
| Switching of highly inductive loads | | 48 | 96 | 144 | 192 | 240 | 288 | 384 | A | - | 13 | 15 | 16 | 23 | 23 | 32 | 40 | 63 |
| f.e. series motors | | 60 | 120 | 180 | 240 | 300 | 360 | 480 | A | - | 12 | 15 | 15 | 23 | 21 | 32 | 40 | 63 |
| Zeitkonstante L/R≤15ms | | 110 | 220 | 330 | 440 | 550 | 660 | - | A | - | 10 | 13 | 14 | 16 | 18 | 25 | - | - |
| | | 220 | 440 | 660 | - | - | - | - | A | - | 1,5 | 1,75 | 1,7 | 1,75 | 2 | 2,5 | - | - |
| | | | | | | | | | A | - | 0,2 | 0,3 | 0,2 | 0,3 | 0,2 | 0,3 | - | - |
| Utilization category DC-13 | | 24 | 48 | - | - | - | - | - | A | CA4 | CA10 | CA10S | CA20 | CA20S | CA25 | CA25S | CA40S | CA63S |
| Control of electromagnets | | 48 | 96 | - | - | - | - | - | A | - | 3 | - | 4 | - | 5 | - | - | - |
| Time constant L/R≤100ms | | 60 | 120 | - | - | - | - | - | A | - | 1,7 | - | 2,4 | - | 3 | - | - | - |
| | | 110 | 220 | - | - | - | - | - | A | - | 1,4 | - | 1,8 | - | 2,5 | - | - | - |
| | | 220 | 440 | - | - | - | - | - | A | - | 0,7 | - | 1 | - | 1,5 | - | - | - |
| | | | | | | | | | A | - | 0,15 | - | 0,35 | - | 0,5 | - | - | - |

¹Cable lug must accept M8 (C200-4) and M12 (C315/C316) screw. ²Values for switches with spring return on request.

[< back to table of contents >](#)

| | | | | | | | | | | | |
|-----------------------|------|------|------|------|------|-------|-------|-------|-------|--|--|
| Selection Data | L350 | | | | L630 | | | | | | |
| | L351 | L400 | L600 | L631 | L800 | L1000 | L1200 | L1600 | L2000 | | |

[< back to table of contents >](#)

| | | | | | | | | | | | | | |
|---|--|-----------------|-------------|---|-----|-----|-----|------|------|-------|--------|--------|------|
| Rated Insulation Voltage U_i | IEC 60947-3, EN 60947-3 ¹ VDE 0660 part 107 ¹ | | V | 690 | 690 | 690 | 690 | 690 | 690 | 690 | 690 | 690 | |
| | UL/Canada ² | | V | 600 | 600 | 600 | 600 | 600 | 600 | 600 | 600 | 600 | |
| | min. voltage | | V | on request | | | | | | | | | |
| Rated Impulse Withstand Voltage U_{imp} | | | kV | 6 | 6 | 6 | 6 | 6 | 6 | 6 | 6 | 6 | |
| Rated Thermal Current I_{th} | IEC 60947-3, EN 60947-3 VDE 0660 part 107 | | | | | | | | | | | | |
| | Ambient temp. +35 °C during 24 hours with peaks up to +40 °C | | A | 350 | 500 | 800 | 630 | 1100 | 1000 | 1450 | 1900 | 2400 | |
| | Ambient temp. +55 °C during 24 hours with peaks up to +60 °C | | A | 350 | 500 | 750 | 600 | 950 | 920 | 1300 | 1700 | 2000 | |
| UL/Canada ² | | A | 350 | 400 | 630 | 630 | 800 | 1000 | 1200 | 1600 | 2000 | | |
| Rated Operational Current I_o | | | | | | | | | | | | | |
| AC-20A No-load operation | IEC 60947-3, EN 60947-3 VDE 0660 part 107 | | 690 V | A | 350 | 500 | 800 | 630 | 1100 | 1000 | 1450 | 1900 | 2400 |
| | Occasional switching under load $\cos \varphi$ 0,8 (AC-20B) | 3 phase, 3 pole | 220 V-440 V | A | 350 | 500 | 800 | 500 | 1000 | 630 | 1200 | 1200 | 1200 |
| | | and | 500 V | A | 350 | 450 | 500 | 450 | 630 | 500 | 800 | 800 | 800 |
| 1 phase, 2 pole | 660 V-690 V | A | 315 | 350 | 400 | 360 | 400 | 400 | 400 | 400 | 400 | 400 | |
| AC-21B Switching of resistive loads, including moderate overloads | 3 phase, 3 pole | 220 V-440 V | A | 250 | 450 | 500 | 350 | 630 | 400 | 800 | 800 | 800 | |
| | and | 500 V | A | 250 | 400 | 450 | 315 | 500 | 350 | 630 | 630 | 630 | |
| | 1 phase, 2 pole | 660 V-690 V | A | 200 | 300 | 350 | 250 | 350 | 300 | 350 | 350 | 350 | |
| Interrupting Rating | UL/Canada ² | | 600 V | A | 200 | 300 | 300 | 200 | 300 | 200 | 300 | 200 | 200 |
| | CSA | | 600 V | A | 200 | 200 | 200 | 200 | 200 | 200 | 200 | 200 | 200 |
| Rated Utilization Category | IEC 60947-3, EN 60947-3 VDE 0660 part 107 | | | | | | | | | | | | |
| AC-23B Occasional switching of motors or other high inductive loads | 3 phase | 220 V-240 V | kW | 45 | 75 | 75 | 45 | 75 | 45 | 75 | 75 | 75 | |
| | 3 pole | 380 V-440 V | kW | 90 | 132 | 132 | 90 | 132 | 90 | 132 | 132 | 132 | |
| | | 500 V | kW | 110 | 132 | 132 | 110 | 132 | 110 | 132 | 132 | 132 | |
| | | 660 V-690 V | kW | 55 | 55 | 65 | 65 | 65 | 65 | 65 | 65 | 65 | |
| Short Circuit Protection | | | | | | | | | | | | | |
| Max. fuse size | (aR-characteristic) | | A | 400 | 500 | 800 | 630 | 1100 | 1000 | 2x800 | 2x1000 | 2x1250 | |
| Rated short-time withstand current | (1s-current) | | A | on request | | | | | | | | | |
| Anschlussklemmen | | | | | | | | | | | | | |
| | for connection screw length | | mm | M12 | M12 | M16 | M16 | M16 | M16 | M16 | 2xM16 | 4xM16 | |
| | | | | 20 | 30 | 40 | 30 | 40 | 40 | 40 | 40 | 50 | 50 |
| Tightening torque of screws | | | | | | | | | | | | | |
| | | | Nm | 25 | 25 | 25 | 25 | 25 | 25 | 25 | 25 | 25 | |
| | | | lb-in | 220 | 220 | 220 | 220 | 220 | 220 | 220 | 220 | 220 | |
| Min. Ambient Temperature of Stages | | | | -5 °C (-25 °C on request) | | | | | | | | | |
| Max. Ambient Temperature of Stages ^{3,4} | | | | 55 °C during 24 hours with peaks up to 60 °C, permissible load see Rated Thermal Current. | | | | | | | | | |

¹Valid for lines with grounded common neutral termination, overvoltage category III, pollution degree 3. Values for other supply systems on request.
²International Standards and Approvals, refer to page 43. ³For electromagnetic optional extras see additional data in Catalog 101. ⁴Storage temperature: -40 °C to 85 °C (in case of temperature below -5 °C no shock load permissible).

| | | | |
|-----------------------|--------|-------|-------|
| Selection Data | CAD4-1 | CAD11 | CAD12 |
|-----------------------|--------|-------|-------|

| | | | | | | | | |
|---|--|---|--|-----------|-----------|----------|-------|-----|
| Bemessungsisolationsspannung U_i | IEC 60947-3, EN 60947-3 ¹ VDE 0660 part 107 | V | 440 | 600 | 600 | | | |
| | SEV ² | V | – | 600 | 600 | | | |
| | North America | V | 300 | 300 | 300 | | | |
| | min. voltage | V | 1 ⁷ | 1 | 6 | | | |
| Rated Impulse Withstand Voltage U_{imp} | | | on request | | | | | |
| Rated Thermal Current I_U/I_{th} | IEC 60947-3, EN 60947-3 VDE 0660 part 107 | A | 5 | 6 | 6 | | | |
| | SEV ² | A | – | 5 | 5 | | | |
| | Nordamerika | A | 5 | 6 | 6 | | | |
| Bemessungsbetriebsstrom I_e | IEC 60947-3, EN 60947-3 VDE 0660 part 107 North America ³ | AC-21A Switching of resistive loads, including moderate overloads | 1 V/6 V | A | 5/2 | 6/3 | –/6 | |
| | | 12 V/24 V | A | 1,2/0,7 | 2/1 | 5/5 | | |
| | | 48 V/110 V | A | 0,45/0,25 | 0,8/0,4 | 4/3 | | |
| | | 220 V/400 V | A | 0,15/– | 0,2/0,13 | 2/1,3 | | |
| | | 440 V/500 V | A | 0,1/– | 0,1/0,08 | 1/0,8 | | |
| | | 600 V | A | – | 0,05 | 0,5 | | |
| | | AC-1 Resistive or low inductive loads | SEV ² | 1 V/6 V | A | – | 5/3 | –/5 |
| | | 12 V/24 V | A | – | 2/1 | 5/5 | | |
| | | 48 V/110 V | A | – | 0,8/0,4 | 4/3 | | |
| | | 220 V/380 V | A | – | 0,2/0,13 | 2/1,3 | | |
| | | 440 V/500 V | A | – | 0,1/0,08 | 1/0,8 | | |
| | | 600 V | A | – | 0,05 | 0,5 | | |
| Power loss per contact at I_U | | W | 0,4 | 0,5 | 0,2 | | | |
| Short Circuit Protection | | | | | | | | |
| Max. fuse size | (gG-characteristic) | A | 5 | 6 | 6 | | | |
| Rated short-time withstand current | (1s-current) | A | 30 | 35 | 50 | | | |
| DC Switching Capacity⁵ | IEC 60947-3, EN 60947-3 VDE 0660 part 107 SEV ² North America ³ | DC-1 Resistive load | 1 V/6 V | A | 3/1,2 | 4/2,5 | –/4 | |
| | | T = 1 ms | 12 V/24 V | A | 0,7/0,4 | 1,5/0,8 | 3/2,2 | |
| | | 48 V/60 V | A | 0,25/0,2 | 0,3/0,27 | 1,2/1 | | |
| | | 110 V/220 V | A | 0,13/– | 0,2/0,1 | 0,6/0,3 | | |
| | | 240 V/500 V | A | 0,08/– | 0,08/0,03 | 0,25/0,1 | | |
| | | 600 V | A | – | 0,02 | 0,1 | | |
| | | Max. Permissible Wire Gage - Use copper wire only | | | | | | |
| Single-core or stranded wire | | mm ² | 2x | 2x | 2x | | | |
| | | AWG | 1,5 | 2,5 | 2,5 | | | |
| Flexible wire (sleeving in accordance with DIN 46228) | | mm ² | 2x | 2x | 2x | | | |
| | | AWG | 1,5 | 2,5 | 2,5 | | | |
| Flexible AWG wires (without sleeve) | | | (1) | (2,5) | (2,5) | | | |
| | | | 16 | 14 | 14 | | | |
| Tightening torque of screws | | | | | | | | |
| | | Nm | 0,4 | 0,6 | 0,6 | | | |
| | | lb-in | 3,5 | 5 | 5 | | | |
| Min. Ambient Temperature of Stages | | | -25 °C (valid only without optional extra) | | | | | |
| Max. Ambient Temperature of Stages^{4,6} | | open at 100 % I_U/I_{th} | 55 °C during 24 hours with peaks up to 60 °C | | | | | |
| | | enclosed at 100 % I_{the} | 35 °C during 24 hours with peaks up to 40 °C | | | | | |

[< back to table of contents >](#)

¹Valid for lines with grounded common neutral termination, overvoltage category III, pollution degree 3. Values for other supply systems on request.
²International Standards and Approvals, refer to page 43. ³Max. 300 V. ⁴For electromagnetic optional extras see additional data in Catalog 101.
⁵Values for switches with spring return on request. ⁶Storage temperature: -40 °C to 85 °C (in case of temperature below -5 °C no shock load permissible).
⁷Values with lower voltages on request.

Two or Four Hole Panel Mounting

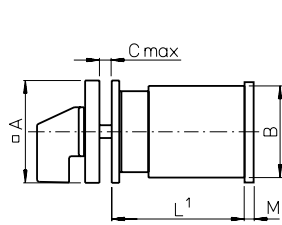

E
for CA4, CA4-1,
CAD4-1

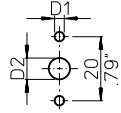

E-V
for CA4, CA4-1,
CAD4-1

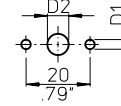

E
E-V
ER

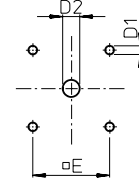

| | CA10 | CA4 | CA11 | CA20 | CA25 ³ | CA20B | CA10B | CA11B | CA25B | C26 | C32 | C42 ³ | C43 | CA40 ³ | CA50 ³ | CA63 ³ | C125 | C200-4 | L switches | L switches | |
|----------------------|---------|---------|---------|---------|-------------------|---------|---------|---------|---------|---------|---------|------------------|----------|-------------------|-------------------|-------------------|----------|----------|------------|------------|------|
| | | CAD4-1 | CAD12 | | | | | | | | | | | | | | | | Size S2 | Size S3 | |
| A | 0 | 48 | 48 | 48 | (64) | 64 | 64 | 64 | 64 | 64 | 64 | 64 | (88) | 88 | 64 | (88) | 88 | 88 | 88 | 130 | |
| | 1.18 | 1.89 | 1.89 | 1.89 | (2.52) | 2.52 | 2.52 | 2.52 | 2.52 | 2.52 | 2.52 | 2.52 | (3.46) | 3.46 | 2.52 | (3.46) | 3.46 | 3.46 | 3.46 | 3.46 | 5.12 |
| B | 29,5 | 43 | 45 | 46 | | 56 | 56 | 58 | 60 | 66 | 66 | 84 | 84 | 55,5x64 | 84 | 88 | 88 | 88 | 88 | 126 | |
| | 1.16 | 1.69 | 1.77 | 1.81 | | 2.20 | 2.20 | 2.28 | 2.36 | 2.60 | 2.60 | 3.30 | 3.30 | 2.19x2.52 | 3.30 | 3.46 | 3.46 | 3.46 | 3.46 | 4.96 | |
| C | 4 | 4 | 4 | 4 | | 4 | 4 | 4 | 4 | 4 | 4 | 5,5 | 4 | 4 | 5,5 | 5,5 | 5,5 | 5,5 | 5,5 | 7 | |
| | .16 | .16 | .16 | .16 | | .16 | .16 | .16 | .16 | .16 | .16 | .22 | .22 | .16 | .22 | .22 | .22 | .22 | .22 | .28 | |
| D1 | 3,2 | 5 | 5 | 5 | | 5 | 5 | 5 | 5 | 5 | 5 | 5 | (6) | 6 | 5 | (6) | 6 | 6 | 6 | 7 | |
| | .13 | .20 | .20 | .20 | | .20 | .20 | .20 | .20 | .20 | .20 | .20 | (.24) | .24 | .20 | (.24) | .24 | .24 | .24 | .28 | |
| D2 | 8-11 | 8-19 | 8-19 | 8-19 | | 10-22 | 10-22 | 10-22 | 10-22 | 10-22 | 10-22 | 10-22 | 13-30 | 10-22 | 10-22 | 13-30 | 13-30 | 13-30 | 13-30 | 15,5-25 | |
| | .31-.43 | .31-.75 | .31-.75 | .31-.75 | | .39-.87 | .39-.87 | .39-.87 | .39-.87 | .39-.87 | .39-.87 | .39-.87 | .51-1.18 | .39-.87 | .39-.87 | .51-1.18 | .51-1.18 | .51-1.18 | .51-1.18 | .61-.98 | |
| E | - | 36 | 36 | 36 | (48) | 48 | 48 | 48 | 48 | 48 | 48 | 48 | (68) | 68 | 48 | (68) | 68 | 68 | 68 | 104 | |
| | - | 1.42 | 1.42 | 1.42 | (1.89) | 1.89 | 1.89 | 1.89 | 1.89 | 1.89 | 1.89 | 1.89 | (2.68) | 2.68 | 1.89 | (2.68) | 2.68 | 2.68 | 2.68 | 4.09 | |
| M² | - | 4,5 | 4,5 | 5,5 | | 5 | 5,5 | 7,5 | 7,5 | 7,5 | 7,5 | 7,5 | 7,5 | 7,6 | 9,4 | 9,4 | 9,4 | 9,4 | 27,5 | 11,9 (32) | |
| | - | .18 | .18 | .22 | | .20 | .22 | .30 | .30 | .30 | .30 | .30 | .30 | .30 | .37 | .37 | .37 | .37 | 1.08 | .47 (1.26) | |

²M, additional length for mounting ER only
³Dimensions in () for ER mounting plate only

⁴Dimensions in () for L800, L1200, L1600

[< back to table of contents >](#)

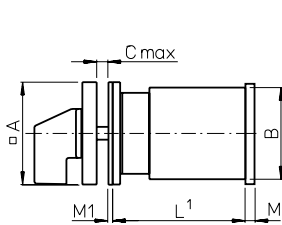

EF
for CA4, CA4-1,
CAD4-1

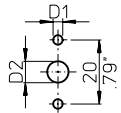

EF-V
for CA4, CA4-1,
CAD4-1

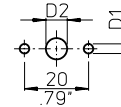

EF
EF-V
ERF

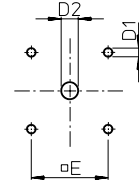

| | CA10 | CA4 | CA11 | CA20 | CA25 ³ | CA20B | CA10B | CA11B | CA25B | C26 | C32 | C42 ³ | C43 | CA40 ³ | CA50 ³ | CA63 ³ | C125 | C200-4 | L switches | L switches |
|----------------------|---------|---------|---------|---------|-------------------|---------|---------|---------|---------|---------|---------|------------------|-----------|-------------------|-------------------|-------------------|-----------|-----------|------------|------------|
| | | CAD4-1 | CAD12 | | | | | | | | | | | | | | | | Size S2 | Size S3 |
| A | 30 | 48 | 48 | 48 | (64) | 64 | 64 | 64 | 64 | 64 | 64 | 64 | (88) | 88 | 64 | (88) | 88 | 88 | 88 | 130 |
| | 1.18 | 1.89 | 1.89 | 1.89 | (2.52) | 2.52 | 2.52 | 2.52 | 2.52 | 2.52 | 2.52 | 2.52 | (3.46) | 3.46 | 2.52 | (3.46) | 3.46 | 3.46 | 3.46 | 5.12 |
| B | 29,5 | 43 | 45 | 46 | | 56 | 56 | 58 | 60 | 66 | 66 | 84 | 84 | 55,5x64 | 84 | 88 | 88 | 88 | 88 | 126 |
| | 1.16 | 1.69 | 1.77 | 1.81 | | 2.20 | 2.20 | 2.28 | 2.36 | 2.60 | 2.60 | 3.30 | 3.30 | 2.19x2.52 | 3.30 | 3.46 | 3.46 | 3.46 | 3.46 | 4.96 |
| C | 4 | 4 | 4 | 4 | | 4 | 4 | 4 | 4 | 4 | 4 | 5,5 | 4 | 4 | 5,5 | 5,5 | 5,5 | 5,5 | 5,5 | 7 |
| | .16 | .16 | .16 | .16 | | .16 | .16 | .16 | .16 | .16 | .16 | .22 | .22 | .16 | .22 | .22 | .22 | .22 | .22 | .28 |
| D1 | 3,2 | 5 | 5 | 5 | | 5 | 5 | 5 | 5 | 5 | 5 | 5 | (6) | 6 | 5 | (6) | 6 | 6 | 6 | 7 |
| | .13 | .20 | .20 | .20 | | .20 | .20 | .20 | .20 | .20 | .20 | .20 | (.24) | .24 | .20 | (.24) | .24 | .24 | .24 | .28 |
| D2 | 8-11 | 15-19 | 15-19 | 15-19 | | 19-22 | 19-22 | 19-22 | 19-22 | 19-22 | 19-22 | 19-22 | 26-30 | 19-22 | 19-22 | 26-30 | 26-30 | 26-30 | 26-30 | 22-25 |
| | .31-.43 | .59-.75 | .59-.75 | .59-.75 | | .75-.87 | .75-.87 | .75-.87 | .75-.87 | .75-.87 | .75-.87 | .75-.87 | 1.02-1.18 | .75-.87 | .75-.87 | 1.02-1.18 | 1.02-1.18 | 1.02-1.18 | 1.02-1.18 | .87-.98 |
| E | - | 36 | 36 | 36 | (48) | 48 | 48 | 48 | 48 | 48 | 48 | 48 | (68) | 68 | 48 | (68) | 68 | 68 | 68 | 104 |
| | - | 1.42 | 1.42 | 1.42 | (1.89) | 1.89 | 1.89 | 1.89 | 1.89 | 1.89 | 1.89 | 1.89 | (2.68) | 2.68 | 1.89 | (2.68) | 2.68 | 2.68 | 2.68 | 4.09 |
| M² | - | 4,5 | 4,5 | 5,5 | | 5 | 5,5 | 7,5 | 7,5 | 7,5 | 7,5 | 7,5 | 7,5 | 7,6 | 9,4 | 9,4 | 9,4 | 9,4 | 27,5 | 11,9 (32) |
| | - | .18 | .18 | .22 | | .20 | .22 | .30 | .30 | .30 | .30 | .30 | .30 | .30 | .37 | .37 | .37 | .37 | 1.08 | .47 (1.26) |
| M1 | 1 | - | - | - | | - | - | - | - | - | - | - | - | - | - | - | - | - | - | - |
| | .04 | - | - | - | | - | - | - | - | - | - | - | - | - | - | - | - | - | - | - |

²M, additional length for mounting ERF only
³Dimensions in () for ERF mounting plate only

⁴Dimensions in () for L800, L1200, L1600

¹see page 56

Two or Four Hole Panel Mounting

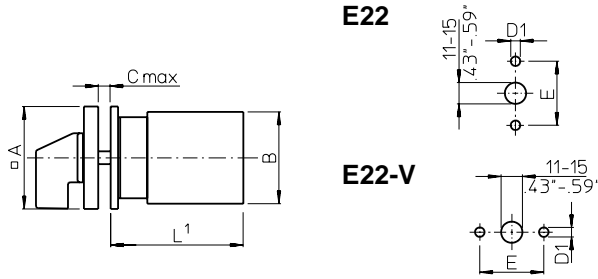

| | CA10 | CA11 | CAD11 | CA20 | CA25 |
|-----------|------------|------------|-------|------------|------------|
| A | 48 1.89 | 48 1.89 | | 48 1.89 | 48 1.89 |
| B | 43 1.69 | 45 1.77 | | 46 1.81 | 46 1.81 |
| C | 4 .16 | 4 .16 | | 4 .16 | 4 .16 |
| D1 | 5 .20 | 5 .20 | | 5 .20 | 5 .20 |
| E | 30 1.17 | 30 1.17 | | 30 1.17 | 30 1.17 |

**EG
EGF**

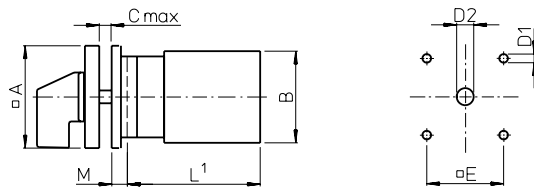

| | CA10 | CA11 | CAD11 | CA20 | CA25 | C26 | C32 | C42 | CA40 | CA50 | CA63 | C80 | C125 | C200-4 |
|------------|------------------|------------------|-------|------------------|------------------|--------------------|--------------------|--------------------|--------------------|----------------------|--------------------|--------------------|--------------------|--------------------|
| | | | | | | | | | | | | | L switches | Size S2 |
| A | 64 2.52 | 64 2.52 | | 64 2.52 | 64 2.52 | 88 3.46 | 88 3.46 | 88 3.46 | 88 3.46 | 88 3.46 | 88 3.46 | 130 5.12 | 130 5.12 | 130 5.12 |
| B | 43 1.69 | 45 1.77 | | 46 1.81 | 46 1.81 | 58 2.28 | 60 2.36 | 66 2.60 | 66 2.60 | 55,5x64 2.19x2.52 | 84 3.30 | 84 3.30 | 88 3.46 | 88 3.46 |
| C | 4 .16 | 4 .16 | | 4 .16 | 4 .16 | 5,5 .22 | 5,5 .22 | 5,5 .22 | 5,5 .22 | 5,5 .22 | 5,5 .22 | 7 .28 | 7 .28 | 7 .28 |
| D1 | 5 .20 | 5 .20 | | 5 .20 | 5 .20 | 6 .24 | 6 .24 | 6 .24 | 6 .24 | 6 .24 | 6 .24 | 7 .28 | 7 .28 | 7 .28 |
| EG | | | | | | | | | | | | | | |
| D2 | 10-22 .39-.87 | 10-22 .39-.87 | | 10-22 .39-.87 | 10-22 .39-.87 | 13-30 .51-1.18 | 13-30 .51-1.18 | 13-30 .51-1.18 | 13-30 .51-1.18 | 13-30 .51-1.18 | 13-30 .51-1.18 | 15,5-25 .61-.98 | 15,5-25 .61-.98 | 15,5-25 .61-.98 |
| EGF | | | | | | | | | | | | | | |
| D2 | 19-22 .75-.87 | 19-22 .75-.87 | | 19-22 .75-.87 | 19-22 .75-.87 | 26-30 1.02-1.18 | 26-30 1.02-1.18 | 26-30 1.02-1.18 | 26-30 1.02-1.18 | 26-30 1.02-1.18 | 26-30 1.02-1.18 | 22-25 .87-.98 | 22-25 .87-.98 | 22-25 .87-.98 |
| E | 48 1.89 | 48 1.89 | | 48 1.89 | 48 1.89 | 68 2.68 | 68 2.68 | 68 2.68 | 68 2.68 | 68 2.68 | 68 2.68 | 104 4.09 | 104 4.09 | 104 4.09 |
| M | 6,7 .26 | 6,7 .26 | | 6,7 .26 | 6,7 .26 | 0,5 .02 | 0,5 .02 | 0,5 .02 | 0,5 .02 | 0,5 .02 | 0,5 .02 | 2 .08 | 2 .08 | 2 .08 |

¹see page 56

Four Hole Panel Mounting or Mosaic Mounting

**E9
E91**

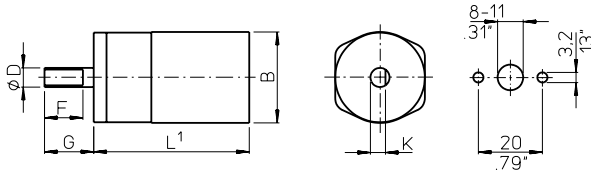

E92

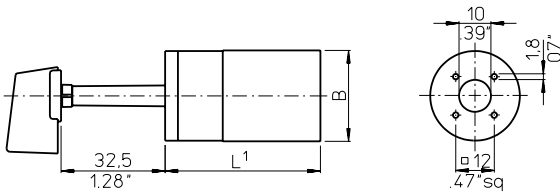

CA4
CA4
CAD4-1
29,5
1.16

B

**E93
E94**

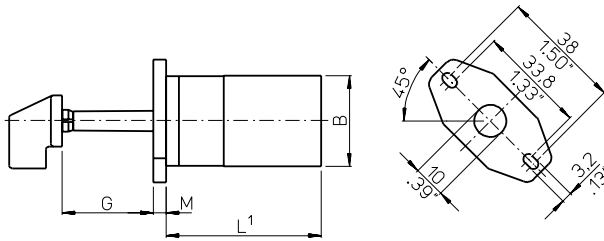

CA4
CA4-1
CAD4-1

| | E9 | E91 | E92 | E93 | E94 |
|----------|-------------|-------------|--------------|--------------|--------------|
| D | 6 .24 | 6,35 .25 | - | - | - |
| F | 12 .47 | 12,8 .50 | - | - | - |
| G | 15,4 .61 | 17,4 .69 | 32,5 1.28 | 28,5 1.12 | 32,5 1.28 |
| K | 4,7 .19 | 5,5 .22 | - | - | - |
| M | - | - | - | 4 .16 | - |

< back to table of contents >

**KN1
KD1
KN2**

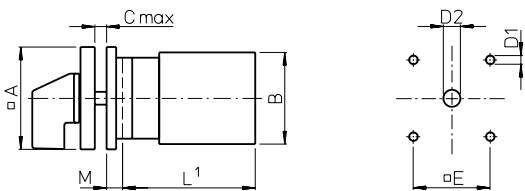

| KN2 | CA10 CA11 CAD11 CAD12 | CA20 | CA25 |
|------------|--------------------------------|-----------------|-----------------|
| A | 48 1.89 | 48 1.89 | 48 1.89 |
| B | 43 1.69 | 45 1.77 | 46 1.81 |
| C | 4 .16 | 4 .16 | 4 .16 |
| D1 | 5 .20 | 5 .20 | 5 .20 |
| D2 | 8-19 .31-.75 | 8-19 .31-.75 | 8-19 .31-.75 |
| E | 36 1.42 | 36 1.42 | 36 1.42 |
| M | 5,2 .20 | 5,2 .20 | 5,2 .20 |

| KN1 KD1 | CA10 CA11 CAD11 CAD12 | CA20 | CA25 | CA10B CA11B CA20B | CA25B | C26 | C32 | C42 | CA40 CA50 CA63 |
|--------------------|--------------------------------|------------------|------------------|-------------------------|------------------|------------------|------------------|------------------|----------------------|
| A | 64 2.52 | 64 2.52 | 64 2.52 | 64 2.52 | 64 2.52 | 64 2.52 | 64 2.52 | 64 2.52 | 64 2.52 |
| B | 43 1.69 | 45 1.77 | 46 1.81 | 56 2.20 | 56 2.20 | 58 2.28 | 60 2.36 | 66 2.60 | 55,5x64 2.19x2.52 |
| C | 4 .16 | 4 .16 | 4 .16 | 4 .16 | 4 .16 | 4 .16 | 4 .16 | 4 .16 | 4 .16 |
| D1 | 5 .20 | 5 .20 | 5 .20 | 5 .20 | 5 .20 | 5 .20 | 5 .20 | 5 .20 | 5 .20 |
| D2 | 10-22 .39-.87 | 10-22 .39-.87 | 10-22 .39-.87 | 10-22 .39-.87 | 10-22 .39-.87 | 10-22 .39-.87 | 10-22 .39-.87 | 10-22 .39-.87 | 10-22 .39-.87 |
| E | 48 1.89 | 48 1.89 | 48 1.89 | 48 1.89 | 48 1.89 | 48 1.89 | 48 1.89 | 48 1.89 | 48 1.89 |
| M | 4,7 .19 | 4,7 .19 | 4,7 .19 | 7 .28 | 7 .28 | 7 .28 | 7 .28 | 7 .28 | 7 .28 |

¹see page 56

Two or Four Hole Panel Mounting

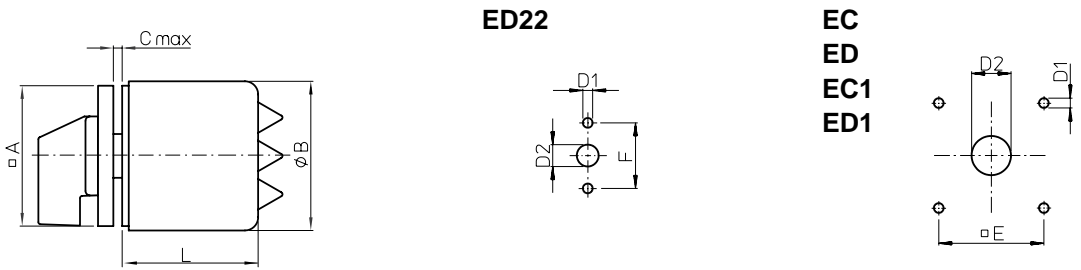

| | CA10 | | | | | | | | | | CA20B | | | | | |
|-------------|---------|---------|---------|---------|---------|---------|---------|---------|---------|---------|---------|---------|---------|---------|---------|---------|
| | CAD11 | | CA11 | | CA20 | | CA25 | | CA10B | | CA11B | | CA25B | | C26 | |
| | EC | | EC | | EC | | EC | | EC | EC1 | EC | EC1 | EC | EC1 | EC | EC1 |
| | ED | ED22 | ED | ED22 | ED | ED22 | ED | ED22 | ED | ED1 | ED | ED1 | ED | ED1 | ED | ED1 |
| A | 48 | 48 | 48 | 48 | 64 | 48 | 64 | 48 | 64 | 64 | 64 | 64 | 64 | 64 | 64 | 64 |
| | 1.89 | 1.89 | 1.89 | 1.89 | 2.52 | 1.89 | 2.52 | 1.89 | 2.52 | 2.52 | 2.52 | 2.52 | 2.52 | 2.52 | 2.52 | 2.52 |
| B | 50 | 74 | 50 | 74 | 68 | 74 | 68 | 74 | 88 | 74 | 88 | 74 | 88 | 74 | 88 | 74 |
| | 1.97 | 2.91 | 1.97 | 2.91 | 2.68 | 2.91 | 2.68 | 2.91 | 3.46 | 2.91 | 3.46 | 2.91 | 3.46 | 2.91 | 3.46 | 2.91 |
| C | 4 | - | 4 | - | 4 | - | 4 | - | 4 | 4 | 4 | 4 | 4 | 4 | 4 | 4 |
| | .16 | - | .16 | - | .16 | - | .16 | - | .16 | .16 | .16 | .16 | .16 | .16 | .16 | .16 |
| ED/ED1/ED22 | 4 | 4 | 4 | 4 | 4 | 4 | 4 | 4 | 4 | 4 | 4 | 4 | 4 | 4 | 4 | 4 |
| | .16 | .16 | .16 | .16 | .16 | .16 | .16 | .16 | .16 | .16 | .16 | .16 | .16 | .16 | .16 | .16 |
| D1 | 5 | 5 | 5 | 5 | 5 | 5 | 5 | 5 | 5 | 5 | 5 | 5 | 5 | 5 | 5 | 5 |
| | .20 | .20 | .20 | .20 | .20 | .20 | .20 | .20 | .20 | .20 | .20 | .20 | .20 | .20 | .20 | .20 |
| EC/EC1 | 8-19 | - | 8-19 | - | 10-22 | - | 10-22 | - | 10-22 | 10-22 | 10-22 | 10-22 | 10-22 | 10-22 | 10-22 | 10-22 |
| | .31-.75 | - | .31-.75 | - | .39-.87 | - | .39-.87 | - | .39-.87 | .39-.87 | .39-.87 | .39-.87 | .39-.87 | .39-.87 | .39-.87 | .39-.87 |
| ED/ED1/ED22 | 15-19 | 11-15 | 15-19 | 11-15 | 19-22 | 11-15 | 19-22 | 11-15 | 19-22 | 19-22 | 19-22 | 19-22 | 19-22 | 19-22 | 19-22 | 19-22 |
| | .43-.75 | .43-.59 | .43-.75 | .43-.59 | .75-.87 | .43-.59 | .75-.87 | .43-.59 | .75-.87 | .75-.87 | .75-.87 | .75-.87 | .75-.87 | .75-.87 | .75-.87 | .75-.87 |
| E | 36 | - | 36 | - | 48 | - | 48 | - | 48 | 48 | 48 | 48 | 48 | 48 | 48 | 48 |
| | 1.42 | - | 1.42 | - | 1.89 | - | 1.89 | - | 1.89 | 1.89 | 1.89 | 1.89 | 1.89 | 1.89 | 1.89 | 1.89 |
| F | - | 30 | - | 30 | - | 30 | - | 30 | - | - | - | - | - | - | - | - |
| | - | 1.17 | - | 1.17 | - | 1.17 | - | 1.17 | - | - | - | - | - | - | - | - |
| ED/ED22 | M | - | - | - | - | - | - | - | - | - | - | - | - | - | - | - |
| | - | - | - | - | - | - | - | - | - | - | - | - | - | - | - | - |
| Stages L | 1 | 53,5 | 74,3 | 53,5 | 74,3 | - | 74,3 | - | 74,3 | - | 73,7 | - | 73,7 | - | 73,7 | - |
| | 2,10 | 2,93 | 2,10 | 2,93 | - | 2,93 | - | 2,93 | - | 2,90 | - | 2,90 | - | 2,90 | - | 2,90 |
| 2 | 53,5 | 74,3 | 53,5 | 74,3 | - | 74,3 | - | 74,3 | - | 73,7 | - | 73,7 | - | 73,7 | - | 73,7 |
| | 2,10 | 2,93 | 2,10 | 2,93 | - | 2,93 | - | 2,93 | - | 2,90 | - | 2,90 | - | 2,90 | - | 2,90 |
| 3 | 67,5 | 74,3 | 67,5 | 94,3 | - | 74,3 | - | 94,3 | - | 73,7 | - | 93,7 | - | 93,7 | - | 93,7 |
| | 2,66 | 2,93 | 2,66 | 3,71 | - | 2,93 | - | 3,71 | - | 2,90 | - | 3,69 | - | 3,69 | - | 3,69 |
| 4 | 67,5 | 74,3 | 81,5 | 94,3 | - | 94,3 | - | 94,3 | - | 93,7 | - | 93,7 | - | 93,7 | - | 93,7 |
| | 2,66 | 2,93 | 3,21 | 3,71 | - | 3,71 | - | 3,71 | - | 3,69 | - | 3,69 | - | 3,69 | - | 3,69 |
| 5 | 81,5 | 94,3 | - | - | 104 | - | 104 | - | - | 93,7 | 104 | - | 127 | - | 114,5 | - |
| | 3,21 | 3,71 | - | - | 4,10 | - | 4,10 | - | - | 3,69 | 4,10 | - | 5 | - | 4,50 | - |
| 6 | 81,5 | 94,3 | - | - | - | - | - | - | 104 | - | 127 | - | 139,5 | - | 127 | - |
| | 3,21 | 3,71 | - | - | - | - | - | - | 4,10 | - | 5 | - | 5,47 | - | 5 | - |
| 7 | - | - | - | - | - | - | - | - | 127 | - | 139,5 | - | 152 | - | 139,5 | - |
| | - | - | - | - | - | - | - | - | 5 | - | 5,47 | - | 5,98 | - | 5,47 | - |
| 8 | - | - | - | - | - | - | - | - | 127 | - | 152 | - | 164,5 | - | 152 | - |
| | - | - | - | - | - | - | - | - | 5 | - | 5,98 | - | 6,48 | - | 5,98 | - |
| 9 | - | - | - | - | - | - | - | - | 139,5 | - | 164,5 | - | 177 | - | 164,5 | - |
| | - | - | - | - | - | - | - | - | 5,47 | - | 6,48 | - | 6,97 | - | 6,48 | - |
| 10 | - | - | - | - | - | - | - | - | 152 | - | 177 | - | - | - | 177 | - |
| | - | - | - | - | - | - | - | - | 5,98 | - | 6,97 | - | - | - | 6,97 | - |
| 11 | - | - | - | - | - | - | - | - | 152 | - | - | - | - | - | - | - |
| | - | - | - | - | - | - | - | - | 5,98 | - | - | - | - | - | - | - |
| 12 | - | - | - | - | - | - | - | - | 164,5 | - | - | - | - | - | - | - |
| | - | - | - | - | - | - | - | - | 6,48 | - | - | - | - | - | - | - |

[< back to table of contents >](#)

Single Hole Mounting or Base Mounting

**FS1...
FT1...
FT3...**

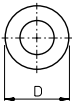

**FS1...
FS2...
FS4...**

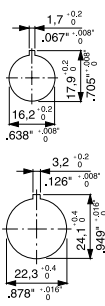

**FH3...
FS2...
FT2...
FT4...**

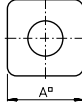

**FH3...
FH4...
FT1...
FT2...
FT6...**

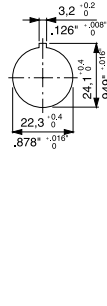

**FH4...
FS4...
FT6...**

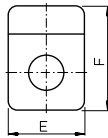

**FT3...
FT4...**

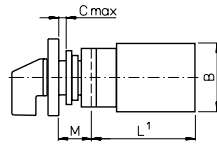
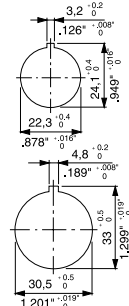

| | CA4 CAD4-1 | CA10 CA11 CAD11 CAD12 | CA20 | CA25 |
|---------------|---------------|--------------------------------|--------------|--------------|
| A/E | 30 1.18 | 48 1.89 | 48 1.89 | 48 1.89 |
| FH3... | - | 64 2.52 | 64 2.52 | 64 2.52 |
| FH4... | - | 64 2.52 | 64 2.52 | 64 2.52 |
| B | 28 1.10 | 43 1.69 | 45 1.77 | 46 1.81 |
| C | 5 .20 | 6 .24 | 6 .24 | 6 .24 |
| D | 29.5 1.16 | 39 1.54 | 39 1.54 | 39 1.54 |
| F | 39 1.54 | 59 2.32 | 59 2.32 | 59 2.32 |
| FH4... | - | 78.5 3.09 | 78.5 3.09 | 78.5 3.09 |
| M | 12.5 .49 | 18.2 .72 | 18.2 .72 | 18.2 .72 |
| FH3... | - | 25.2 .99 | 25.2 .99 | 25.2 .99 |
| FH4... | - | 25.2 .99 | 25.2 .99 | 25.2 .99 |

< back to table of contents >

VE

VE-V

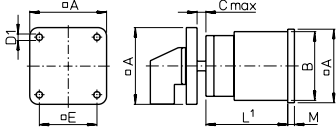

VE22

VE22V

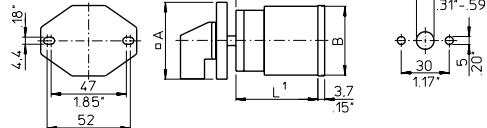

VF

VF-V

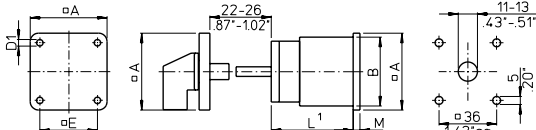

VF22

VF22V

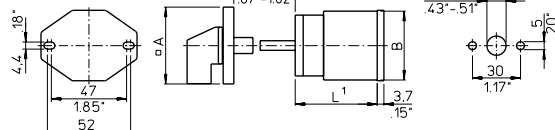

| | CA10 CA11 CAD11 CAD12 | CA20 | CA25 ² | CA10B CA11B CA20B | CA25B | C26 | C32 | C42 ² | C43 | CA40 ² CA50 ² CA63 ² | C125 C80 | C200-4 | L switches Size S2 | L switches Size S3 |
|-----------|--------------------------------|-----------------|------------------------|-------------------------|------------------|------------------|------------------|------------------------|-------------------|---|-------------------|-------------------|-----------------------|---------------------------|
| A | 48 1.89 | 48 1.89 | 48 (64) 1.89 (2.52) | 64 2.52 | 64 2.52 | 64 2.52 | 64 2.52 | 64 (88) 2.52 (3.46) | 88 3.46 | 64 (88) 2.52 (3.46) | 88 3.46 | 88 3.46 | 88 3.46 | 128 5.04 |
| B | 43 1.69 | 45 1.77 | 46 1.81 | 56 2.20 | 56 2.20 | 58 2.28 | 60 2.36 | 66 2.60 | 84 3.30 | 55.5x64 2.19x2.52 | 84 3.30 | 88 3.46 | 88 3.46 | 126 4.96 |
| C | 10.5 .41 | 10.5 .41 | 10.5 .41 | 13.5 .53 | 13.5 .53 | 13.5 .53 | 13.5 .53 | 16 .63 | 16 .63 | 13.5 .53 | 16 .63 | 16 .63 | 16 .63 | 19.3 .76 |
| D1 | 4.1 .16 | 4.1 .16 | 4.1 .16 | 4.1 .16 | 4.1 .16 | 4.1 .16 | 4.1 .16 | 5.4 .21 | 5.4 .21 | 5.4 .21 | 5.4 .21 | 5.4 .21 | 5.4 .21 | 7 .28 |
| D2 | 5 .20 | 5 .20 | 5 .20 | 5 .20 | 5 .20 | 5 .20 | 5 .20 | 5 .20 | 6 .24 | 5 (6) .20 (.24) | 6 .24 | 6 .24 | 6 .24 | 7 .28 |
| D3 | 8-19 .31-.75 | 8-19 .31-.75 | 8-19 .31-.75 | 10-22 .39-.87 | 10-22 .39-.87 | 10-22 .39-.87 | 10-22 .39-.87 | 10-22 .39-.87 | 13-30 .51-1.18 | 10-22 .39-.87 | 13-30 .51-1.18 | 13-30 .51-1.18 | 13-30 .51-1.18 | 15.5-25 .61-.98 |
| E | 36 1.42 | 36 1.42 | 36 (48) 1.42 (1.89) | 48 1.89 | 48 1.89 | 48 1.89 | 48 1.89 | 48 (68) 1.89 (2.68) | 68 2.68 | 48 (68) 1.89 (2.68) | 68 2.68 | 68 2.68 | 68 2.68 | 104 4.09 |
| M | 2.2 .09 | 2.2 .09 | 3.2 .13 | 2.5 .10 | 2.5 .10 | 5 .20 | 5 .20 | 5 .20 | 7 .28 | 5.1 .21 | 8.9 .35 | 8.9 .35 | 27 1.06 | 11.4 (31.9) .45 (1.25) |

²Dimensions in () for revertive mounting plate

³Dimensions in () for L800, L1200, L1600

¹see page 56

Base Mounting

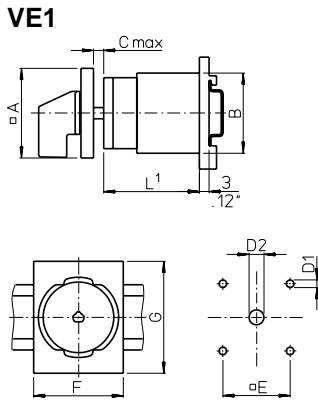

| | CA10 | CA11 | CAD11 | CA20 | CA25 | CA10B | CA11B | CA20B | CA25B | C26 | C32 | C42 | CA40 | CA50 | CA63 |
|-----------|---------|---------|---------|---------|---------|---------|---------|---------|---------|---------|---------|---------|-----------|-----------|-----------|
| A | 48 | 48 | 48 | 48 | 48 | 64 | 64 | 64 | 64 | 64 | 64 | 64 | 64 | 64 | 64 |
| | 1.89 | 1.89 | 1.89 | 1.89 | 1.89 | 2.52 | 2.52 | 2.52 | 2.52 | 2.52 | 2.52 | 2.52 | 2.52 | 2.52 | 2.52 |
| B | 43 | 45 | 46 | 46 | 46 | 56 | 56 | 56 | 58 | 60 | 60 | 66 | 55,5x64 | 55,5x64 | 55,5x64 |
| | 1.69 | 1.77 | 1.81 | 1.81 | 1.81 | 2.20 | 2.20 | 2.20 | 2.28 | 2.36 | 2.36 | 2.60 | 2.19x2.52 | 2.19x2.52 | 2.19x2.52 |
| C | 10,5 | 10,5 | 10,5 | 10,5 | 10,5 | 13,5 | 13,5 | 13,5 | 13,5 | 13,5 | 13,5 | 13,5 | 13,5 | 13,5 | 13,5 |
| | .41 | .41 | .41 | .41 | .41 | .53 | .53 | .53 | .53 | .53 | .53 | .53 | .53 | .53 | .53 |
| D1 | 5 | 5 | 5 | 5 | 5 | 5 | 5 | 5 | 5 | 5 | 5 | 5 | 5 | 5 | 5 |
| | .20 | .20 | .20 | .20 | .20 | .20 | .20 | .20 | .20 | .20 | .20 | .20 | .20 | .20 | .20 |
| D2 | 8-15 | 8-15 | 8-15 | 8-15 | 8-15 | 10-15 | 10-15 | 10-15 | 10-15 | 10-15 | 10-15 | 10-15 | 10-15 | 10-15 | 10-15 |
| | .31-.59 | .31-.59 | .31-.59 | .31-.59 | .31-.59 | .39-.59 | .39-.59 | .39-.59 | .39-.59 | .39-.59 | .39-.59 | .39-.59 | .39-.59 | .39-.59 | .39-.59 |
| E | 36 | 36 | 36 | 36 | 36 | 48 | 48 | 48 | 48 | 48 | 48 | 48 | 48 | 48 | 48 |
| | 1.42 | 1.42 | 1.42 | 1.42 | 1.42 | 1.89 | 1.89 | 1.89 | 1.89 | 1.89 | 1.89 | 1.89 | 1.89 | 1.89 | 1.89 |
| F | 48 | 48 | 48 | 48 | 48 | 70 | 70 | 70 | 70 | 70 | 70 | 70 | 70 | 70 | 70 |
| | 1.89 | 1.89 | 1.89 | 1.89 | 1.89 | 2.76 | 2.76 | 2.76 | 2.76 | 2.76 | 2.76 | 2.76 | 2.76 | 2.76 | 2.76 |
| G | 60 | 60 | 60 | 60 | 60 | 60 | 60 | 60 | 60 | 60 | 60 | 60 | 60 | 60 | 60 |
| | 2.36 | 2.36 | 2.36 | 2.36 | 2.36 | 2.36 | 2.36 | 2.36 | 2.36 | 2.36 | 2.36 | 2.36 | 2.36 | 2.36 | 2.36 |

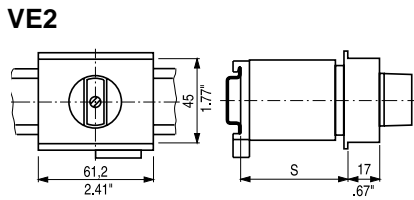

VE21 (for CA4, CA4-1 and CAD4-1)

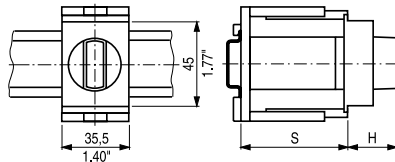

VE21 (for CA10-CA20)

VE21V (for CA25)

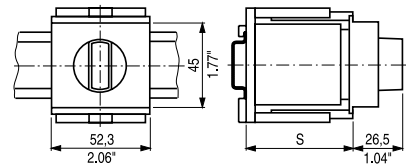

| | VE2 | | | | S_{min.} | H | VE21, VE21V | | | | |
|-----------------------|------------------------|----------------------|------|--------------------|-------------------------|--------------|--------------------|-----------------------|------|------|---------------|
| | CA10 CAD11 CAD12 | CA11 CA20 CL10 | CA25 | Max. no. of stages | | | CA4 CAD4-1 | CA10 CAD11 CA11 | CA20 | CA25 | No. of stages |
| S = 46 1.81 | 3 | 1 | - | | 44 1.73 | 21 .83 | 1/2 | 1/2 | 1/2 | 1/2 | 1 |
| S = 50 1.97 | 3 | 1 | 1 | | 46 1.81 | 26,5 1.04 | 3 | 3 | - | - | 2 |
| S = 61 2.40 | 4 | 2 | 2 | | 54 2.13 | 26,5 1.04 | 4 | - | - | - | - |
| S = 67 2.64 | 5 | 2 | 2 | | 56 2.20 | - | - | - | 3 | 3 | - |
| S = 69 2.70 | 5 | 3 ² | 3 | | 60 2.36 | - | - | - | - | - | 3 |
| | | | | | 62 2.44 | 26,5 1.04 | 5 | - | - | - | - |
| | | | | | 66 2.60 | - | - | 4/5 | - | - | - |
| | | | | | 68 2.68 | - | - | - | 4 | - | - |
| | | | | | 70 2.76 | 26,5 1.04 | 6 | - | - | 4 | - |
| | | | | | 74 2.91 | - | - | 6 | - | - | 4 |

¹see page 56 ²not available for switch type CA20

Wall Mounting, Face plates and Additional Length

UE1
UE2
UE3

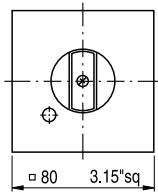

Lamp

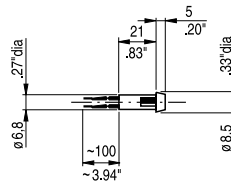

Face plates for mounting E, EF, ER, ERF, EG, EGF, KN1, KD1, KN2, EC, EC1, ED, ED1, VE, VE1, VF

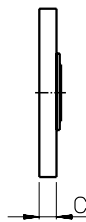
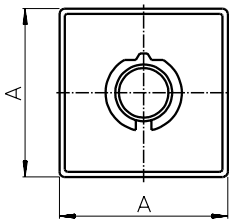

| Size | A | C |
|------------|-------------|-------------|
| S00 | 30 1.18 | 5,5 .22 |
| S0 | 48 1.89 | 6,3 .25 |
| S1 | 64 2.52 | 7,4 .29 |
| S2 | 88 3.46 | 8,5 .33 |
| S3 | 130 5.12 | 11,5 .45 |

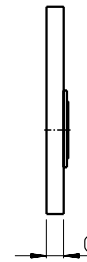
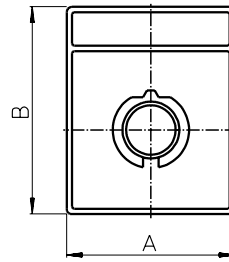

| Size | A | B | C |
|------------|------------|------------|------------|
| S00 | 30 1.18 | 39 1.54 | 5,5 .22 |
| S0 | 48 1.89 | 59 2.32 | 6,7 .26 |
| S1 | 64 2.52 | 78 3.07 | 7,4 .29 |

< back to table of contents >

Additional length for amendment (page 6)

| Amendment | | Amendment | | | | | |
|-----------|---|----------------|------------------------------|-------------|-------------|-------------|----------------------|
| | | CAD11 CAD12 | CA10 CA11 CA20 CA25 | C26 | C32 | C42 | CA40 CA50 CA63 |
| B | S0 switches with latching mechanism size S1 | 5,4 .21 | - | - | - | - | - |
| C | S1 switches with latching mechanism size S2 | - | - | 9,2 .36 | 9,2 .36 | - | 8,2 .32 |
| S | with snap action | - | 17,3 .68 | 12,2 .48 | 12,2 .48 | 12,2 .48 | 12,2 .48 |

Quick connects for switches CA4-4

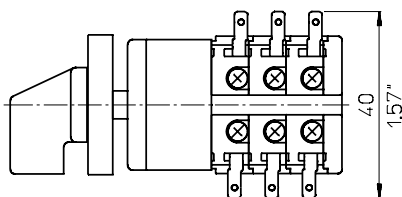

Additional Length

Terminal lugs for switches C200-4-, C315, C316 and L switches

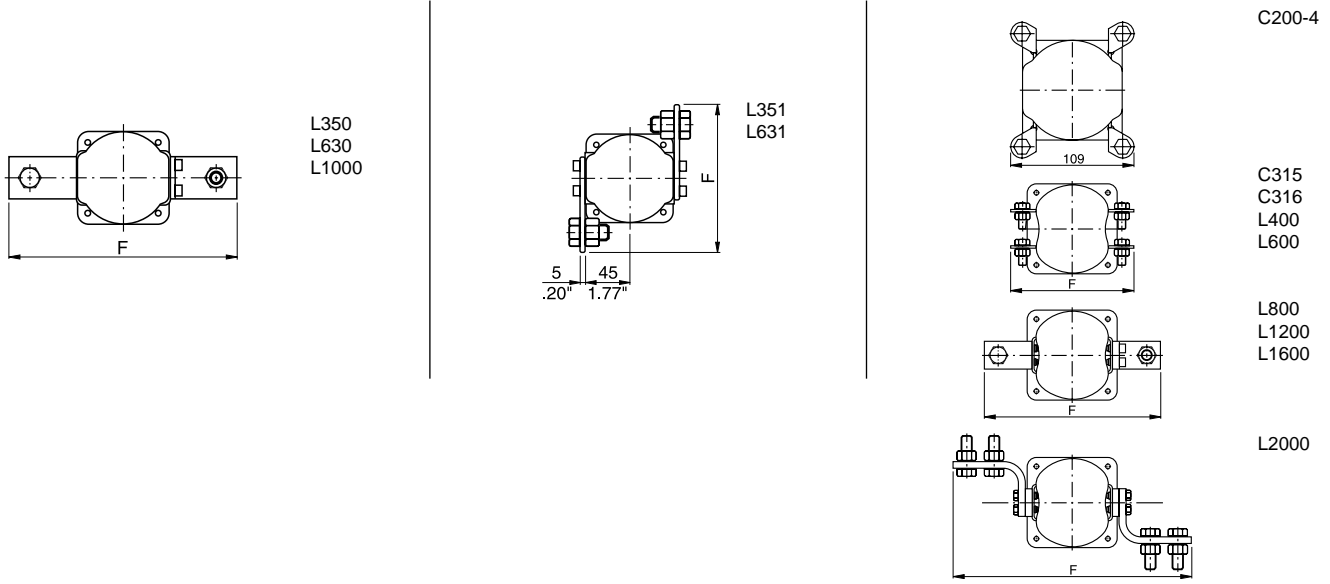

| | L350 | L630 | L1000 | L351 | L631 | C315 C316 | L400 | L600 | L800 L1200 | L1600 L2000 |
|----------|-------------|-------------|-------------|-------------|-------------|--------------|-------------|-------------|---------------|----------------|
| F | 190 7.48 | 220 8.66 | 230 9.06 | 138 5.43 | 148 5.83 | 150 5.91 | 180 7.09 | 208 8.19 | 256 10.08 | 326 12.83 |

Length L

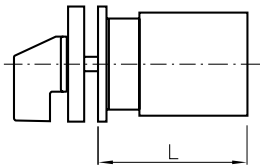

| Stages | CA4 | CA10 | | | | | | | | | CA40 | C125 | C315 | | | | |
|-----------|------------|---------------|---------------|---------------|-------------|---------------|---------------|---------------|---------------|---------------|---------------|----------------|----------------|---------------|----------------|-----------------------|-----------------------|
| | CA4-1 | CAD11 | CA11 | CA20 | CA25 | CA10B | CA11B | CA20B | CA25B | C26 | C32 | C42 | C43 | CA50 | C80 | L switches Size S2 | L switches Size S3 |
| 1 | 30 1.18 | 33,5 1.32 | 36,7 1.44 | 37,7 1.48 | 39 1.51 | 38,9 1.53 | 42,1 1.66 | 43,1 1.70 | 44,4 1.75 | 42 1.65 | 46,8 1.84 | 50,8 2.00 | 59 2.32 | 42,5 1.67 | 61,5 2.42 | 67,5 2.66 | 78,6 3.09 |
| 2 | 38 1.50 | 43 1.69 | 49,4 1.94 | 50,4 1.98 | 53 2.09 | 48,4 1.91 | 54,8 2.16 | 55,8 2.20 | 58,4 2.30 | 54,7 2.15 | 64,3 2.51 | 72,3 2.85 | 80,5 3.17 | 55,2 2.17 | 88,0 3.46 | 100 3.94 | 117,2 4.61 |
| 3 | 46 1.81 | 52,5 2.07 | 62,1 2.44 | 63,1 2.48 | 67 2.64 | 57,9 2.28 | 67,5 2.66 | 68,5 2.70 | 72,4 2.85 | 67,4 2.65 | 81,8 3.22 | 93,8 3.69 | 102 4.02 | 67,9 2.67 | 114,5 4.51 | 132,5 5.22 | 155,8 6.13 |
| 4 | 54 2.13 | 62 2.44 | 74,8 2.94 | 75,8 2.98 | 81 3.19 | 67,4 2.65 | 80,2 3.16 | 81,2 3.20 | 86,4 3.40 | 80,1 3.15 | 99,3 3.91 | 115,3 4.54 | 123,5 4.86 | 80,6 3.17 | 141 5.55 | 165 6.50 | 194,4 7.65 |
| 5 | 62 2.44 | 71,5 2.81 | 87,5 3.44 | 88,5 3.48 | 95 3.74 | 76,9 3.03 | 92,9 3.66 | 93,9 3.70 | 100,4 3.95 | 92,8 3.65 | 116,8 4.60 | 136,8 5.39 | 145 5.71 | 93,3 3.67 | 167,5 6.59 | 197,5 7.78 | 233 9.17 |
| 6 | 70 2.76 | 81 3.19 | 100,2 3.94 | 101,2 3.98 | 109 4.29 | 86,4 3.40 | 105,6 4.16 | 106,6 4.20 | 114,4 4.50 | 105,5 4.15 | 134,3 5.29 | 158,3 6.23 | 166,5 6.56 | 106 4.17 | 194 7.64 | 230 9.06 | 271,6 10.69 |
| 7 | 78 3.07 | 90,5 3.56 | 112,9 4.44 | 113,9 4.48 | 123 4.84 | 95,9 3.78 | 118,3 4.66 | 119,3 4.70 | 128,4 5.05 | 118,2 4.65 | 151,8 5.98 | 179,8 7.08 | 188 7.40 | 118,7 4.67 | 220,5 8.68 | 262,5 10.33 | 310,2 12.21 |
| 8 | 86 3.39 | 100 3.94 | 125,6 4.94 | 126,6 4.98 | 137 5.39 | 105,4 4.15 | 131 5.16 | 132 5.20 | 142,4 5.60 | 130,9 5.15 | 169,3 6.67 | 201,3 7.93 | 209,5 8.25 | 131,4 5.17 | 247 9.72 | 295 11.61 | 348,8 13.73 |
| 9 | 94 3.70 | 109,5 4.31 | 138,3 5.44 | 139,3 5.48 | 151 5.94 | 114,9 4.52 | 143,7 5.66 | 144,7 5.70 | 156,4 6.15 | 143,6 5.65 | 186,8 7.36 | 222,8 8.77 | 231 9.09 | 144,1 5.67 | 273,5 10.77 | 327,5 12.89 | 387,4 15.25 |
| 10 | - | 119 4.68 | 151 5.94 | 152 5.98 | 165 6.50 | 124,4 4.90 | 156,4 6.16 | 157,4 6.20 | 170,4 6.70 | 156,3 6.15 | 204,3 8.04 | 244,3 9.62 | 252,2 9.54 | 156,8 6.17 | 300 11.81 | 360 14.17 | 426 16.77 |
| 11 | - | 128,5 5.06 | 163,7 6.44 | 164,7 6.48 | 179 7.05 | 133,9 5.27 | 169,1 6.66 | 170,1 6.70 | 184,4 7.25 | 169 6.65 | 221,8 8.73 | 265,8 10.46 | 274 10.79 | 169,5 6.67 | 326,5 12.85 | 392,5 15.45 | 464,6 18.29 |
| 12 | - | 138 5.43 | 176,4 6.94 | 177,4 6.98 | 193 7.60 | 143,4 5.65 | 181,8 7.16 | 182,8 7.20 | 198,4 7.80 | 181,7 7.15 | 239,3 9.42 | 287,3 11.31 | 295,5 11.63 | 182,2 7.17 | 353 13.90 | 425 16.73 | 503,2 19.81 |

Notes:

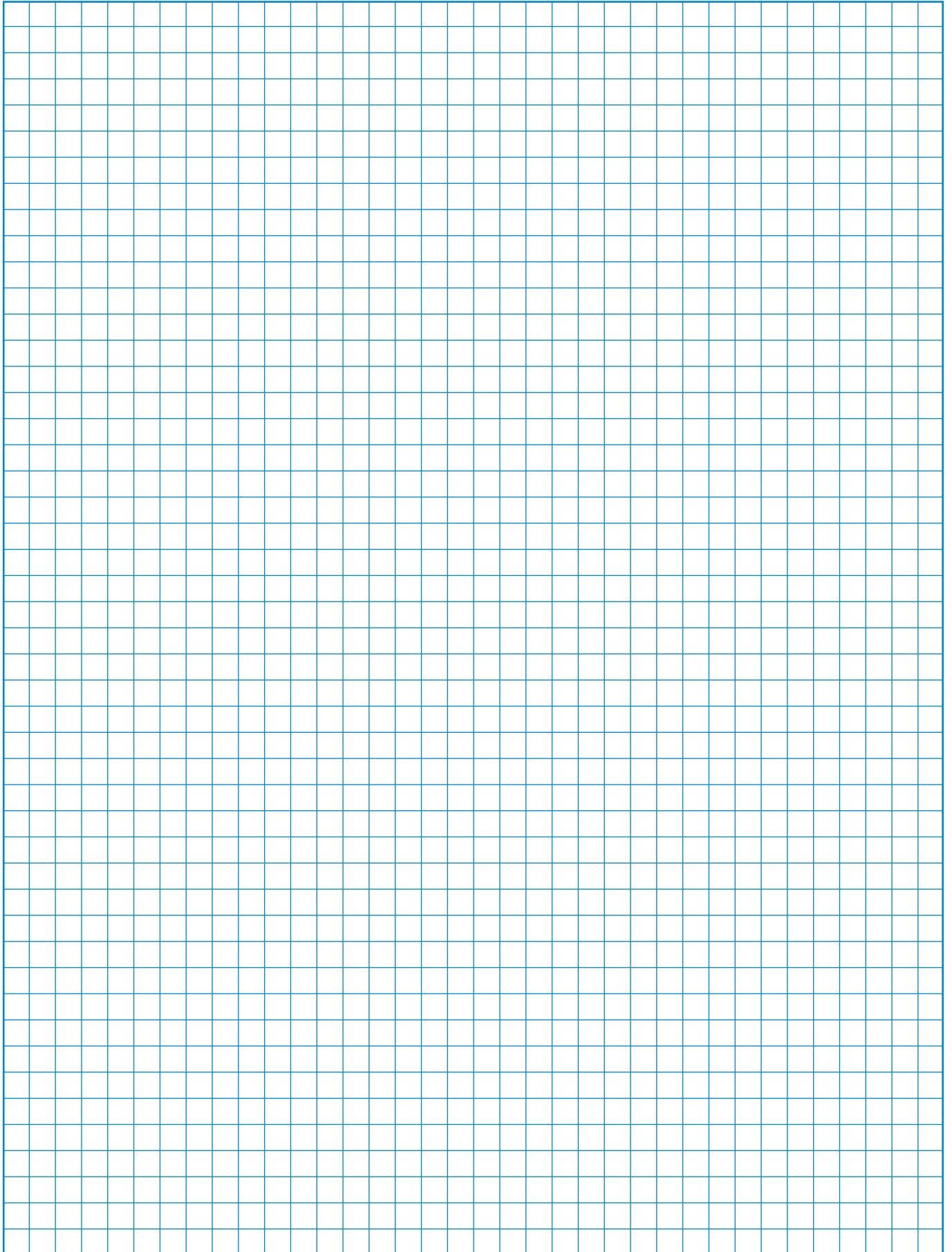

[< back to table of contents >](#)

The Range of “Blue Line” Switchgear

Technical literature covering the following products is available on request.

| | Catalog Number |
|--|---------------------------|
| Main Switches and Main Switches with Emergency Function 16 A-315 A Maintenance Switches 20 A-315 A Switch Disconnectors 20 A-315 A According to IEC 60947-3, EN 60947-3, VDE 0660 part 107, IEC 60204, EN 60204 and VDE 0113 | 500 |
| C, CA and CAD Switches 10 A-315 A and L Switches 350 A-2400 A C, CA and CAD switches are designed for universal application. They are recommended for instrument, isolator, double-throw and motor control. L switches are designed for load and off-load applications. They are used to switch resistive or low inductive loads. | 100 |
| Optional Extras and Enclosures The complete product line, a large number of optional extras is available, including door interlocks, push-pull devices, cylinder and padlock attachments, control and indicator devices, AC motor drives, as well as enclosures, both insulated and metal. | 101 |
| A and AD Switches 6 A-25 A A and AD switches have 4 contacts in each switching stage. These switches provide an extensive range of switch functions and require a minimum mounting depth. Up to 24 switching positions are possible, with availability of 48 contacts per 12 stage switch column. | 110 |
| CG, CH and CHR Switches 10 A-25 A Ultra compact CG, CH and CHR switches are ideally suited for control and instrumentation applications. Switch terminals are “finger-proof” and conveniently accessible for wiring and are delivered open. All CG4 switches offer specially designed gold plated contacts or H-bridges with “cross-wire” contact systems, which facilitates their use in electronic circuitry and chemically aggressive environments. | 120 |
| DH, DHR, DK and DKR Switches 6 A-16 A DH, DHR, DK and DKR switches incorporate unique corrosion resistant contacts that permit operation on system voltage as low as 1 V. They have fully enclosed and protected contacts which can be operated either by rotary and/or lateral handle movement. D switches are used in calibration and semiconductor circuits. They are also used for relay and contactor control. | 130 |
| X Switches 200 A-630 A X switches can be applied for load, tap and gang switching duties. They incorporate 6 contacts in each switching stage. Their compact design provides a minimum length dimension for mounting purposes. | 140 |
| KG Switches 20 A-315 A and KH and KHR Switches 16 A-80 A KG, KH and KHR switches are excellent circuit interruptors. They have high through fault and fault making capacities and are especially designed for use as isolators and safety switches for machine tools, distribution panels and switchboards. KG ON/OFF switches offer unusually high dimensioned air and creepage distances between terminals which are designed for time saving “straight-line” wiring. ON/OFF switches are available with up to 8 poles and double-throw switches are available with up to 4 poles. | 150 |
| Push Buttons and Pilot Lights, 22,5 mm Ø A complete range of state-of-the-art push buttons and pilot lights represent an ideal combination of functional security and economical efficiency in a modular design. | 302 |

SALES AND SERVICE ORGANIZATION

Australia

Kraus & Naimer Pty. Ltd.
379 Liverpool Road, ASHFIELD, N.S.W. 2131
Tel: +61 2 9797-7333, Fax: 0092
salesaus@krausnaimer.com

Austria

Kraus & Naimer GmbH
Schumanngasse 35
1180 WIEN
Tel: +43 1 404 06-0, Fax: 404 06-190
aso@krausnaimer.com

Belgium, Luxembourg

Kraus & Naimer B.V.
Ikaros Business Park
Ikaroslaan 2
1930 ZAVENTHEM
Tel: +32 2 757-0141, Fax: 1640
sales.be@krausnaimer.com

Brazil

Central and South America
Kraus & Naimer Ind. Com. Ltda.
Rua Santa Monica, 1061
Parque Industrial San Jose
06715-865 Cotia - SP
Tel: +55 11 2198-1288, Fax: 1251
knbrasil@krausnaimer.com.br

Canada

Kraus & Naimer Ltd.
219 Connie Crescent, Unit: 13A
CONCORD, Ontario, L4K 1L4
Tel: +1 905 738-1666, Fax: 9327
salescan@krausnaimer.com

Cyprus

ELECTROMATIC CONSTRUCTIONS LTD.
72, Evagoras Pellikarides Str., 2235 LATSIA-Nicosia
P. O. Box 12630, 2251 LATSIA-Nicosia
Tel: +357 2 48 41 41, Fax: 48 57 47

Czech Republic

OBZOR, výrobní družstvo Zlín
Na Slanici 378
76413 ZLÍN
Tel: +420 57 7195-111/-153 (Techn. Supp.)
Fax: +420 57 7195-152/-138
ots@obzor.cz

Denmark

THIIM A/S
Transformervej 31
2730 HERLEV
Tel: +45 4485 8000, Fax: 8005
thiim@thiim.com

Finland

Kraus & Naimer Oy
Kiitoradankuja 8
01530 VANTAA
Tel: +358 9 825-424-0, Fax: 424-10
myynti@krausnaimer.com

France

Kraus & Naimer s.a.s.
33, rue Bobillot
75013 PARIS
Tel: +33 1 58 40 80 80, Fax: 45 80 91 19
ventes@krausnaimer.com

Germany

Kraus & Naimer GmbH
Wikingerstraße 20-28, 76189 KARLSRUHE
Postfach 10 01 24, 76231 KARLSRUHE
Tel: +49 721 59 88-0, Fax: 59 28 28
sales.ger@krausnaimer.com

Great Britain

Kraus & Naimer Ltd.
115 London Road
NEWBURY/BERKSHIRE RG14 2AH
Tel: +44 1635 262626, Fax: 37807
sales-uk@krausnaimer.com

Greece

KALAMARAKIS-SAPOUNAS S. A.
Ionias & Neromilou Str., P. O. Box 46566
13671 ACHARNES/ATHENS
Tel: +30 2 10 240-6000-6, Fax: 240-6007
kalamarakis.sapounas@ksa.gr

Hungary

GANZ, Schalter- u. Gerätefabrik
X. Kőbányai út 41/c, Postfach 87
1475 BUDAPEST
Tel: +36 1 261-5479, Fax: 4685
ganzkk@ganzkk.hu

Iceland

JOHAN RÖNNING LTD.
Klettagarðar 25
104 REYKJAVÍK
Tel: +354 5200 800
ronning@ronning.is

India

BLISS ELECTRICALS Pvt. Ltd.
SA42 A&B, 2nd Flr, Lake City Mall,
Kapurbavdi Junction,
THANE (W) - 400 607
Tel: +91-22-25368609
kane.shriram@blisselectricals.com

Republic of Ireland

Kraus & Naimer Ltd.
4235 Atlantic Avenue
Westpark Business Campus
Shannon, Co. Clare
Tel: +353 61 704700, Fax: 471084
sales-ie@krausnaimer.com

Italy

Kraus & Naimer s.r.l.
Via Terracini, 9
24047 TREVIGLIO (BG)
Tel: +39 0363-30 11 12, Fax: 30 21 13
SalesItaly@krausnaimer.com

Japan

Kraus & Naimer Ltd.
Yoshiwada Building 2F
1-11-6 Hamamatsucho
Minato-Ku, TOKYO 105-0013
Tel: +81 3 3436-6151, Fax: 6325
sales-jpn@krausnaimer.com

Mexico

JC Ingeniería y Control, SA de CV.
Ángel Gaviño 30.
C. Satélite, C. Medicos,
Naucalpan Edo. de Mexico, C.P. 53100
Tel. (+52 55) 55 62 75 77, Fax. 55 62 04 34
ventas@jcingeneriaycontrol.com

Middle East - UAE

Branch Office, Kraus & Naimer Pte. Ltd.
SAIF Zone, P. O. Box 121607,
Sharjah, UAE
Tel: +971 6 557 8886
Fax: +971 6 557 8088
uae@krausnaimer.com

Netherlands

Kraus & Naimer B.V.
Wegtersweg 38-40, Postbus 199
7556 BR HENGEL0 (Ov.)
Tel: +31 74 291-9441, Fax: 8380
sales.nl@krausnaimer.com

New Zealand

Kraus & Naimer Ltd.
42 Miramar Avenue, WELLINGTON 6022
P. O. Box 15-009, WELLINGTON 6243
Tel: +64 4 380-9888, Fax: 9877
sales-nz@krausnaimer.com

Norway

Kraus & Naimer AS
Hjalmar Brantings vei 8, P. O. Box 21, Økern
0508 OSLO
Tel: +47 22 64 44 20, Fax: 65 39 49
ordre.no@krausnaimer.com

Poland

ASTAT sp. z o.o.
ul. Dąbrowskiego 461
60451 POZNAN
Tel: +48 61 848-8871/72, Fax: 8276
info@astat.com.pl

Portugal

ELECTRICOL-DAMAS, FERREIRA & DAMASCENO, LDA.
Apartado 1063, S. Ant. Cavaleiros
2670 LOURES
Tel: +351 21 989-8939, Fax: 988-6464
electrical@electricol.pt

Singapore

Kraus & Naimer Pte. Ltd.
Blk 115A, Commonwealth Drive
#03-17/23
SINGAPORE 149 596
Tel: +65 6473-8166, Fax: 8643
sgp@krausnaimer.com

Slovenia

SCHRACK Technik d.o.o.
Pameče 175
2380 Slovenj Gradec
Tel: +386 2 883 92 00, Fax: +386 2 884 34 71
m.abeln@schrack.si

Republic of South Africa

Kraus & Naimer Pty. Ltd.
7 Village Crescent, Linbro Village
Linbro Business Park, SANDTON 2065
P. O. Box 511, KELVIN 2054
Tel: +27 11 608-6060, Fax: 608-2874
salesZAF@krausnaimer.com

Spain

Kraus & Naimer B.V.
Tel: +34 662 696 014
sales.es@krausnaimer.com

Sweden

Kraus & Naimer AB
Dr. Widerströms Gata 11, FRUÅNGEN
Box 42097, 126 14 STOCKHOLM
Tel: +46 8 97 00 80, Fax: 97 87 33
order.se@krausnaimer.com

Switzerland

AWAG Elektrotechnik AG
Sandbühlstraße 2, Postfach
8604 VOLKETSCHWIL
Tel: +41 44 908 19 19, Fax: 19 99
info@awag.ch, www.awag.ch

Turkey

KARDEŞ ELEKTRİK SANAYİ VE TİCARET ANONİM ŞİRKETİ
Beşyol, Eski Londra Asfaltı-6
34295 İSTANBUL-Sefaköy
Tel: +90 212 624-9204, Fax: 592-4810
info@unalkardes.com.tr

USA

Kraus & Naimer Inc.
760 New Brunswick Road
SOMERSET, NJ 08873
Tel: +1 732 560-1240, Fax: 8823
salesusa@krausnaimer.com



Kraus & Naimer

BLUE LINE switchgear



Contact us:

www.krausnaimer.com